



Molded Door Facing

Dimensional Specifications

January 2016



- Molded Panel Series**
- Anniversary Collection**
- Palazzo Series®**
- West End™ Collection**
- Heritage**

Table of Contents

Molded Panel

	6/8	7/0	8/0
Two Panel Arch Top Smooth	3	4	5
Two Panel Arch Top Text	6	x	x
Two Panel Roman Smooth	7	8	9
Two Panel Roman Commercial Smooth	10	11	x
Two Panel Smooth	12	13	14
Two Panel Commercial Smooth	15	16	x
Three Panel Text	17	x	x
Four Panel Smooth	18	19	20
Four Panel Text	21	x	x
Four Panel Arch Top Text	22	x	x
Six Panel Smooth	23	24	25
Six Panel Text	26	27	28
Six Panel Pre-stained Text	29	x	x
Six Panel White Text	30	x	x
Six Panel Commercial Smooth	31	32	x

Anniversary Collection

Riverside™	33	34	35
Saddlebrook™	36	x	37
Cheyenne®	38	x	39
Glenview™	40	x	x

Palazzo Series®

Capri®	41	42	43
Bellagio®	44	45	46
Treviso®	47	48	49

West End™ Collection

Melrose™	50	51	x
Berkley™	52	53	x
Hamel™	54	55	x

Shaker

3P Mission	56	57	x
1P Shaker	58	59	60

Two Panel Arch Top

Smooth

Height: 6'8"

	Smallest	Largest
Height Range:	72.4	80.0
Bore Location (from top, on center):	31.2 - 41.6	34.8 - 45.2
Bifold:	71.4	79.0

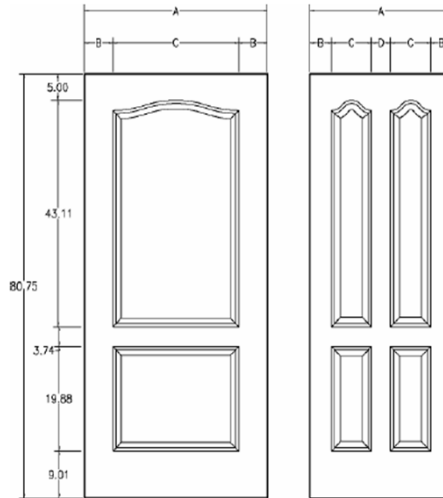
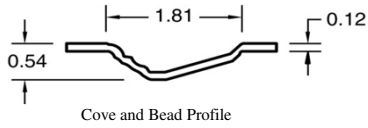

(for bifolds)

Door Facing Size (Nominal)	A	B	C	D	Minimum Door Size (if not next size down)	Max Trim, one side
36	36.375	5.69	25.00	--	next size down	1.0
34	34.375	5.77	22.84	--	next size down	1.0
32	32.375	4.77	22.84	--	31.3	0.3
30	30.375	5.35	19.69	--	28.1	0.9
28	28.375	5.13	18.11	--	26.5	0.7
26	26.375	5.71	14.96	--	next size down	1.0
24	24.375	4.71	14.96	--	23.4	0.3
20	20.375	5.44	9.50	--	next size down	1.0
18	18.375	4.44	9.50	--	18.0	-
16U	--	--	--	--	--	--
18/18 B	36.375	6.19	9.50	5.00	17 / 17	1.0
16/16 B	32.375	4.78	9.50	3.81	15 / 15	1.0
15/15 B	30.375	4.61	8.68	3.81	14 / 14	1.0
14/14 B	--	--	--	--	--	-
12/12 B	24.375	3.49	6.79	3.81	11 / 11	1.0
9/9 B	--	--	--	--	--	-
18/18 M	--	--	--	--	--	-

Overall Length and Width Dimensions are + 1/16 inch

Two Panel Arch Top Smooth

Height: 7'0"

	Smallest	Largest
Height Range:	80.0	84.0
Bore Location (from top, on center):	34.8 - 45.2	38.8 - 49.2
Bifold:	79.0	79.0

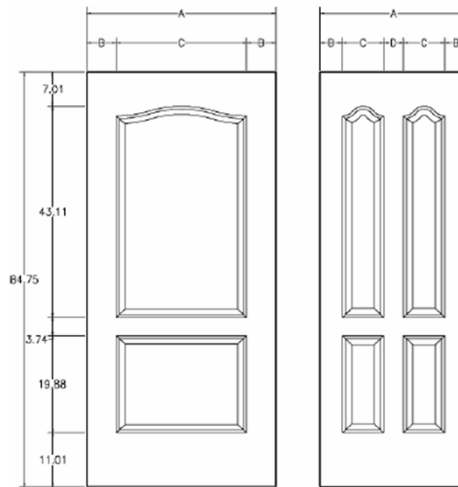
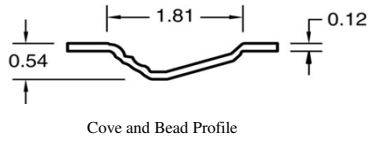

(for bifolds)

Door Facing Size (Nominal)	A	B	C	D	Smallest Allowable Door Width (if not next size down)	Max Trim, one side
36	36.375	5.69	25.00	--	next size down	1.0
34	34.375	5.77	22.84	--	next size down	1.0
32	32.375	4.77	22.84	--	31.3	0.3
30	30.375	5.35	19.69	--	28.1	0.9
28	28.375	5.13	18.11	--	26.5	0.7
26	26.375	5.71	14.96	--	next size down	1.0
24	24.375	4.71	14.96	--	23.4	0.3
20	20.375	5.44	9.50	--	next size down	1.0
18	18.375	4.44	9.50	--	18.0	-
16U	--	--	--	--	--	-
18/18 B	36.375	6.19	9.50	5.00	17 / 17	-
16/16 B	32.375	4.78	9.50	3.81	15 / 15	-
15/15 B	30.375	4.61	8.68	3.81	14 / 14	-
14/14 B	--	--	--	--	--	-
12/12 B	24.375	3.49	6.79	3.81	11 / 11	-
9/9 B	--	--	--	--	--	-
18/18 M	--	--	--	--	--	-

Overall Length and Width Dimensions are + 1/16 inch

Two Panel Arch Top

Smooth

Height: 8'0"

	Smallest	Largest
Height Range:	88.0	96.0
Bore Location (from top, on center):	46.8 - 57.2	50.8 - 61.2
Bifold:	--	79.0

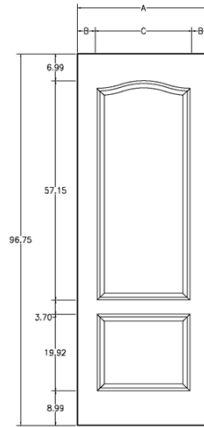
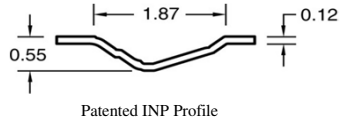

Door Facing Size (Nominal)	A	B	C	D	Smallest Allowable Door Width (if not next size down)	Max Trim, one side
36	36.375	5.69	25.00	--	next size down	1.0
34	34.375	5.77	22.84	--	next size down	1.0
32	32.375	4.77	22.84	--	31.3	0.3
30	30.375	5.35	19.69	--	28.1	0.9
28	28.375	5.13	18.11	--	26.5	0.7
26	26.375	5.71	14.96	--	next size down	1.0
24	24.375	4.71	14.96	--	23.4	0.3
20	20.375	5.44	9.50	--	next size down	1.0
18	18.375	4.44	9.50	--	18.0	-
16U	16.375	4.65	7.08	--	15.5	0.2
18/18 B	--	--	--	--	--	-
16/16 B	--	--	--	--	--	-
15/15 B	--	--	--	--	--	-
14/14 B	--	--	--	--	--	-
12/12 B	--	--	--	--	--	-
9/9 B	--	--	--	--	--	-
18/18 M	--	--	--	--	--	-

Overall Length and Width Dimensions are + 1/16 inch

Two Panel Arch Top Textured

Height: 6'8"

	Smallest	Largest
Height Range:	72.4	80.0
Bore Location (from top, on center):	31.2 - 41.6	34.8 - 45.2
Bifold:	71.4	79.0

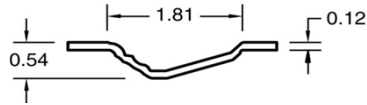

Cove and Bead Profile

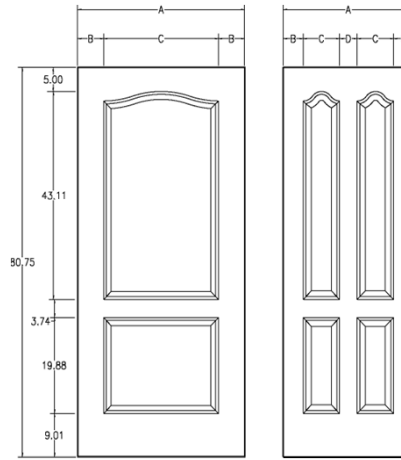

(for bifolds)

Door Facing Size (Nominal)	A	B	C	D	Smallest Allowable Door Width (if not next size down)	Max Trim, one side
36	36.375	5.69	25.00	--	next size down	1.0
34	34.375	5.77	22.84	--	next size down	1.0
32	32.375	4.77	22.84	--	31.3	0.3
30	30.375	5.35	19.69	--	28.1	0.9
28	28.375	5.13	18.11	--	26.5	0.7
26	26.375	5.71	14.96	--	next size down	1.0
24	24.375	4.71	14.96	--	23.4	0.3
20	20.375	5.44	9.50	--	next size down	1.0
18	18.375	4.44	9.50	--	18.0	-
16U	16.375	4.69	7.00	--	15.4	0.3
18/18 B	36.375	6.19	9.50	5.00	17 / 17	-
16/16 B	32.375	4.78	9.50	3.81	15 / 15	-
15/15 B	30.375	4.61	8.68	3.81	14 / 14	-
14/14 B	28.375	4.34	7.94	3.81	--	-
12/12 B	24.375	3.49	6.79	3.81	11 / 11	-
9/9 B	--	--	--	--	--	-
18/18 M	--	--	--	--	--	-

Overall Length and Width Dimensions are + 1/16 inch

Two Panel Roman Smooth

Height: 6'8"

	Smallest	Largest
Height Range:	72.4	80.0
Bore Location (from top, on center):	38.7 - 42.3	42.3 - 45.9
Bifold:	71.4	79.0

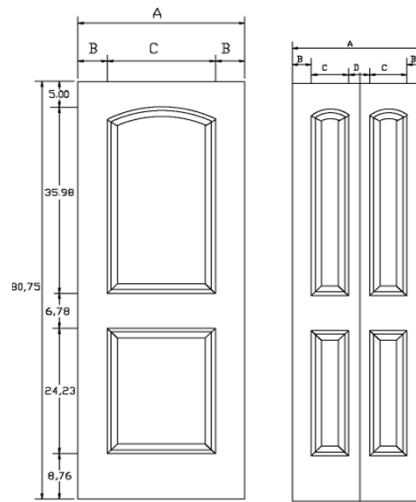
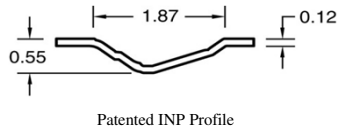

Door Facing Size (Nominal)	A	B	C	D	Smallest Allowable Door Width (if not next size down)	Max Trim, one side
36	36.375	6.34	23.69	--	next size down	1.0
34	34.375	6.34	21.69	--	next size down	1.0
32	32.375	5.34	21.69	--	30.1	0.9
30	30.375	5.34	19.69	--	28.1	0.9
28	28.375	5.34	17.69	--	26.1	0.9
26	26.375	5.34	15.69	--	24.1	0.9
24	24.375	4.34	15.69	--	24.0	-
20	20.375	4.21	11.96	--	20.0	-
18	18.375	3.21	11.96	--	18.0	-
16U	16.375	4.65	7.08	--	15.5	0.2
18/18 B	36.375	6.19	9.50	5.00	17 / 17	-
16/16 B	--	--	--	--	--	-
15/15 B	30.375	4.60	8.68	3.81	14 / 14	-
14/14 B	--	--	--	--	--	-
12/12 B	24.375	3.50	6.79	3.81	11 / 11	-
9/9 B	--	--	--	--	--	-
18/18 M	--	--	--	--	--	-

Overall Length and Width Dimensions are + 1/16 inch

Two Panel Roman Smooth

Height: 7'0"

	Smallest	Largest
Height Range:	80.0	84.0
Bore Location (from top, on center):	34.8 - 45.2	38.8 - 49.2
Bifold:	79.0	79.0

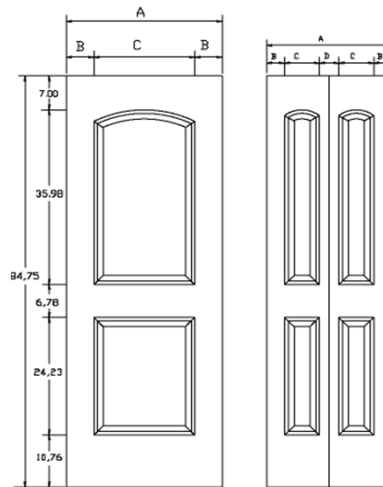
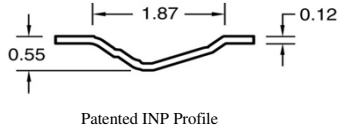

Door Facing Size (Nominal)	A	B	C	D	Smallest Allowable Door Width (if not next size down)	Max Trim, one side
36	36.375	6.34	23.69	--	next size down	1.0
34	34.375	6.34	21.69	--	next size down	1.0
32	32.375	5.34	21.69	--	30.1	0.9
30	30.375	5.34	19.69	--	28.1	0.9
28	28.375	5.34	17.69	--	26.1	0.9
26	26.375	5.34	15.69	--	24.1	0.9
24	24.375	4.34	15.69	--	24.0	-
20	20.375	4.21	11.96	--	20.0	-
18	18.375	3.21	11.96	--	18.0	-
16U	16.375	4.65	7.08	--	15.5	0.2
18/18 B	36.375	6.19	9.50	5.00	17 / 17	1.0
16/16 B	--	--	--	--	--	--
15/15 B	30.375	4.60	8.68	3.81	14 / 14	0.2
14/14 B	--	--	--	--	--	--
12/12 B	24.375	3.50	6.79	3.81	11 / 11	-
9/9 B	--	--	--	--	--	-
18/18 M	--	--	--	--	--	-

Overall Length and Width Dimensions are + 1/16 inch

Two Panel Roman Smooth

Height: 8'0"

	Smallest	Largest
Height Range:	88.0	96.0
Bore Location (from top, on center):	46.8 - 57.2	50.8 - 61.2
Bifold:	--	79.0

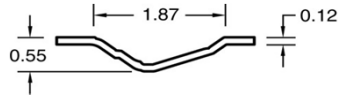

Patented INP Profile

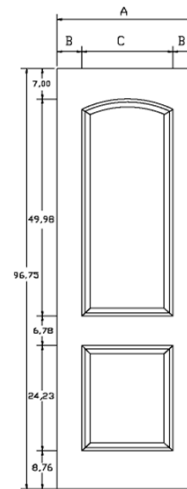

Door Facing Size (Nominal)	A	B	C	D	Smallest Allowable Door Width (if not next size down)	Max Trim, one side
36	36.375	6.34	23.69	--	next size down	1.0
34	34.375	6.34	21.69	--	next size down	1.0
32	32.375	5.34	21.69	--	30.1	0.9
30	30.375	5.34	19.69	--	28.1	0.9
28	28.375	5.34	17.69	--	26.1	0.9
26	26.375	5.34	15.69	--	24.1	0.9
24	24.375	4.34	15.69	--	24.0	-
20	20.375	4.21	11.96	--	20.0	-
18	18.375	3.21	11.96	--	18.0	-
16U	--	--	--	--	--	-
18/18 B	--	--	--	--	--	-
16/16 B	--	--	--	--	--	-
15/15 B	--	--	--	--	--	-
14/14 B	--	--	--	--	--	-
12/12 B	--	--	--	--	--	-
9/9 B	--	--	--	--	--	-
18/18 M	--	--	--	--	--	-

Overall Length and Width Dimensions are + 1/16 inch

Two Panel Roman Commercial Smooth

Height: 6'8"

	Smallest	Largest
Height Range:	75.7	80.0
Bore Location (from top, on center):	38.7 - 42.3	42.3 - 45.9
Bifold:	--	79.0

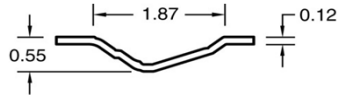

Patented INP Profile

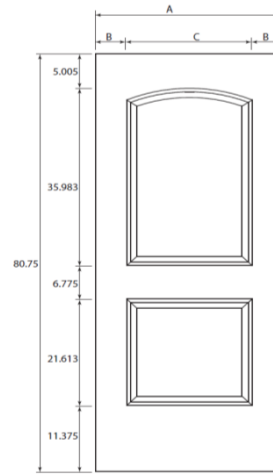

Door Facing Size (Nominal)	A	B	C	D	Smallest Allowable Door Width (if not next size down)	Max Trim, one side
36	36.375	6.69	22.99	--	next size down	1.0
34	34.375	5.69	22.99	--	next size down	1.0
32	32.375	6.34	19.69	--	next size down	1.0
30	30.375	5.34	19.69	--	28.1	0.9
28	--	--	--	--	--	-
26	--	--	--	--	--	-
24	--	--	--	--	--	-
20	--	--	--	--	--	-
18	--	--	--	--	--	-
16U	--	--	--	--	--	-
18/18 B	--	--	--	--	--	-
16/16 B	--	--	--	--	--	-
15/15 B	--	--	--	--	--	-
14/14 B	--	--	--	--	--	-
12/12 B	--	--	--	--	--	-
9/9 B	--	--	--	--	--	-
18/18 M	--	--	--	--	--	-

Overall Length and Width Dimensions are + 1/16 inch

Two Panel Roman Commercial Smooth

Height: 7'0"

	Smallest	Largest
Height Range:	80.0	84.0
Bore Location (from top, on center):	34.8 - 45.2	38.8 - 49.2
Bifold:	--	79.0

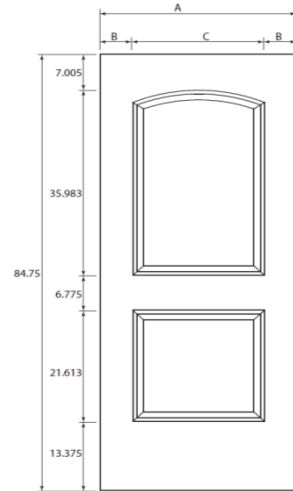
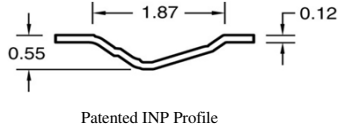

Door Facing Size (Nominal)	A	B	C	D	Smallest Allowable Door Width (if not next size down)	Max Trim, one side
36	36.375	6.69	22.99	--	next size down	1.0
34	34.375	5.69	22.99	--	next size down	1.0
32	32.375	6.34	19.69	--	next size down	1.0
30	30.375	5.34	19.69	--	28.1	0.9
28	--	--	--	--	--	-
26	--	--	--	--	--	-
24	--	--	--	--	--	-
20	--	--	--	--	--	-
18	--	--	--	--	--	-
16U	--	--	--	--	--	-
18/18 B	--	--	--	--	--	-
16/16 B	--	--	--	--	--	-
15/15 B	--	--	--	--	--	-
14/14 B	--	--	--	--	--	-
12/12 B	--	--	--	--	--	-
9/9 B	--	--	--	--	--	-
18/18 M	--	--	--	--	--	-

Overall Length and Width Dimensions are + 1/16 inch

Two Panel Smooth

Height: 6'8"

	Smallest	Largest
Height Range:	72.9	80.0
Bore Location (from top, on center):	39.4 - 42.6	42.6 - 45.7
Bifold:	--	79.0

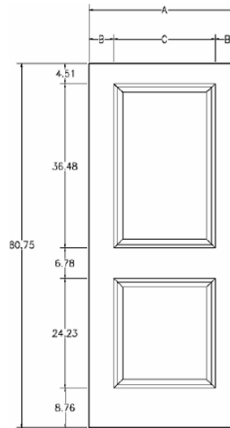
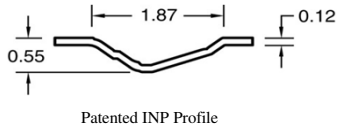

Door Facing Size (Nominal)	A	B	C	D	Smallest Allowable Door Width (if not next size down)	Max Trim, one side
36	36.375	6.34	23.69	--	next size down	1.0
34	34.375	6.34	21.69	--	next size down	1.0
32	32.375	5.34	21.69	--	30.1	0.9
30	30.375	5.34	19.69	--	28.1	0.9
28	28.375	5.34	17.69	--	26.1	0.9
26	26.375	5.34	15.69	--	24.1	0.9
24	24.375	4.34	15.69	--	24.0	-
20*	20.375	4.21	11.96	--	20*	-
18*	18.375	3.21	11.96	--	18*	-
16U*	16.375	4.65	7.08	--	15.5	0.2
18/18 B	--	--	--	--	--	-
16/16 B	--	--	--	--	--	-
15/15 B	--	--	--	--	--	-
14/14 B	--	--	--	--	--	-
12/12 B	--	--	--	--	--	-
9/9 B	--	--	--	--	--	-
18/18 M	--	--	--	--	--	-

Overall Length and Width Dimensions are + 1/16 inch
 *Note: Four Panel Smooth SKU'S (one panel wide)

Two Panel Smooth

Height: 7'0"

	Smallest	Largest
Height Range:	80.0	84.0
Bore Location (from top, on center):	34.8 - 45.2	38.8 - 49.2
Bifold:	--	79.0

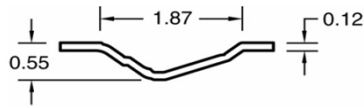

Patented INP Profile

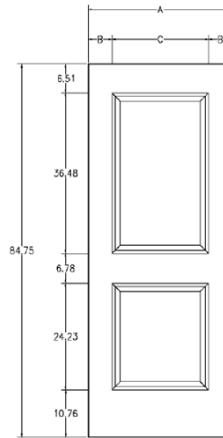

Door Facing Size (Nominal)	A	B	C	D	Smallest Allowable Door Width (if not next size down)	Max Trim, one side
36	36.375	6.34	23.69	--	next size down	1.0
34	34.375	6.34	21.69	--	next size down	1.0
32	32.375	5.34	21.69	--	30.1	0.9
30	30.375	5.34	19.69	--	28.1	0.9
28	28.375	5.34	17.69	--	26.1	0.9
26	26.375	5.34	15.69	--	24.1	0.9
24	24.375	4.34	15.69	--	24.0	-
20*	20.375	4.21	11.96	--	20*	-
18*	18.375	3.21	11.96	--	18*	-
16U*	16.375	4.65	7.08	--	15.5	0.2
18/18 B	--	--	--	--	--	-
16/16 B	--	--	--	--	--	-
15/15 B	--	--	--	--	--	-
14/14 B	--	--	--	--	--	-
12/12 B	--	--	--	--	--	-
9/9 B	--	--	--	--	--	-
18/18 M	--	--	--	--	--	-

Overall Length and Width Dimensions are + 1/16 inch
 *Note: Four Panel Smooth SKU'S (one panel wide)

Two Panel Smooth

Height: 8'0"

	Smallest	Largest
Height Range:	88.0	96.0
Bore Location (from top, on center):	46.8 - 57.2	50.8 - 61.2
Bifold:	--	79.0

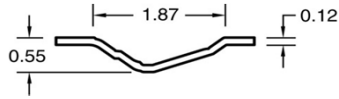

Patented INP Profile

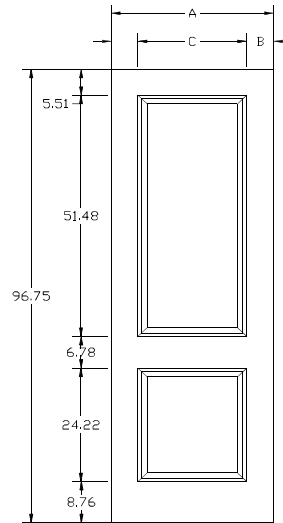

Door Facing Size (Nominal)	A	B	C	D	Smallest Allowable Door Width (if not next size down)	Max Trim, one side
36	36.375	6.34	23.69	--	next size down	1.0
34	34.375	6.34	21.69	--	next size down	1.0
32	32.375	5.34	21.69	--	30.1	0.9
30	30.375	5.34	19.69	--	28.1	0.9
28	28.375	5.34	17.69	--	26.1	0.9
26	26.375	5.34	15.69	--	24.1	0.9
24	24.375	4.34	15.69	--	24.0	-
20*	20.375	4.21	11.96	--	20*	-
18*	18.375	3.21	11.96	--	18*	-
16U*	16.375	4.65	7.08	--	15.5	0.2
18/18 B	--	--	--	--	--	-
16/16 B	--	--	--	--	--	-
15/15 B	--	--	--	--	--	-
14/14 B	--	--	--	--	--	-
12/12 B	--	--	--	--	--	-
9/9 B	--	--	--	--	--	-
18/18 M	--	--	--	--	--	-

Overall Length and Width Dimensions are + 1/16 inch

Two Panel Commercial Smooth

Height: 6'8"

	Smallest	Largest
Height Range:	76.2	80.0
Bore Location (from top, on center):	39.2 - 42.8	42.3 - 45.9
Bifold:	--	79.0

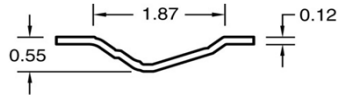

Patented INP Profile

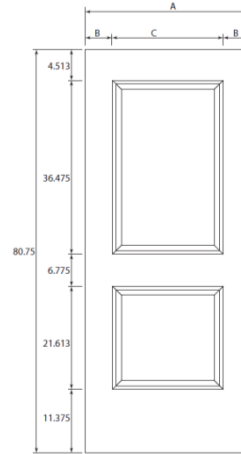

Door Facing Size (Nominal)	A	B	C	D	Smallest Allowable Door Width (if not next size down)	Max Trim, one side
36	36.375	6.69	22.99	--	next size down	1.0
34	34.375	5.69	22.99	--	next size down	1.0
32	32.375	6.34	19.69	--	next size down	1.0
30	30.375	5.34	19.69	--	28.1	0.9
28	--	--	--	--	--	-
26	--	--	--	--	--	-
24	--	--	--	--	--	-
20	--	--	--	--	--	-
18	--	--	--	--	--	-
16U	--	--	--	--	--	-
18/18 B	--	--	--	--	--	-
16/16 B	--	--	--	--	--	-
15/15 B	--	--	--	--	--	-
14/14 B	--	--	--	--	--	-
12/12 B	--	--	--	--	--	-
9/9 B	--	--	--	--	--	-
18/18 M	--	--	--	--	--	-

Overall Length and Width Dimensions are + 1/16 inch

Two Panel Commercial Smooth

Height: 7'0"

	<u>Smallest</u>	<u>Largest</u>
Height Range:	80.0	84.0
Bore Location (from top, on center):	34.8 - 45.2	38.8 - 49.2
Bifold:	--	79.0

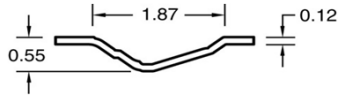

Patented INP Profile

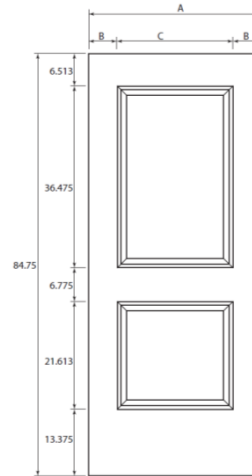

Door Facing Size (Nominal)	A	B	C	D	Smallest Allowable Door Width (if not next size down)	Max Trim, one side
36	36.375	6.69	22.99	--	next size down	1.0
34	34.375	5.69	22.99	--	next size down	1.0
32	32.375	6.34	19.69	--	next size down	1.0
30	30.375	5.34	19.69	--	28.1	0.9
28	--	--	--	--	--	-
26	--	--	--	--	--	-
24	--	--	--	--	--	-
20	--	--	--	--	--	-
18	--	--	--	--	--	-
16U	--	--	--	--	--	-
18/18 B	--	--	--	--	--	-
16/16 B	--	--	--	--	--	-
15/15 B	--	--	--	--	--	-
14/14 B	--	--	--	--	--	-
12/12 B	--	--	--	--	--	-
9/9 B	--	--	--	--	--	-
18/18 M	--	--	--	--	--	-

Overall Length and Width Dimensions are + 1/16 inch

Three Panel Textured

Height: 6'8"

	Smallest	Largest
Height Range:	72.6	80.0
Bore Location (from top, on center):	31.4 - 41.7	34.8 - 45.2
Bifold:	71.6	79.0

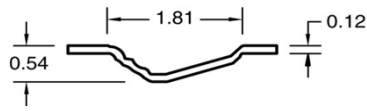

Cove and Bead Profile

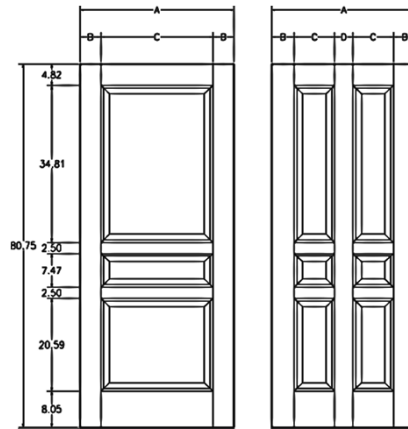

Door Facing Size (Nominal)	A	B	C	D	Smallest Allowable Door Width (if not next size down)	Max Trim, one side
36	36.375	4.41	27.56	--	36.0	-
34	34.375	5.38	23.62	--	next size down	1.0
32	32.375	4.38	23.62	--	32.0	-
30	30.375	4.72	20.94	--	29.4	0.3
28	28.375	4.35	19.68	--	28.0	-
26	26.375	5.31	15.75	--	24.2	0.9
24	24.375	4.31	15.75	--	24.0	-
20	20.375	5.44	9.49	--	next size down	1.0
18	18.375	4.44	9.49	--	18.0	-
16U	16.375	4.69	7.00	--	15.4	0.3
18/18 B	36.375	6.20	9.49	5.00	17 / 17	1.0
16/16 B	32.375	4.38	9.90	3.82	15 / 15	-
15/15 B	30.375	4.73	8.54	3.82	14 / 14	0.3
14/14 B	--	--	--	--	--	-
12/12 B	24.375	3.59	6.69	3.82	11 / 11	-
9/9 B	--	--	--	--	--	-
18/18 M	--	--	--	--	--	-

Overall Length and Width Dimensions are + 1/16 inch

Four Panel Smooth

Height: 6'8"

	Smallest	Largest
Height Range:	72.9	80.0
Bore Location (from top, on center):	39.2 - 42.8	42.3 - 45.9
Bifold:	--	79.0

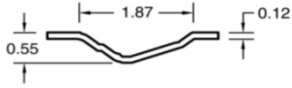

Patented INP Profile

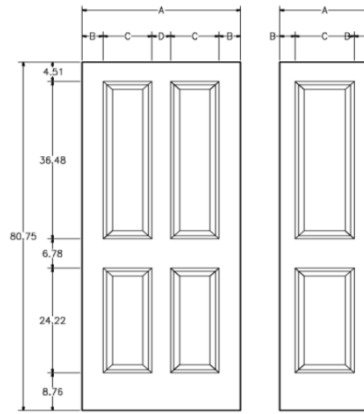

Door Facing Size (Nominal)	A	B	C	D	Smallest Allowable Door Width (if not next size down)	Max Trim, one side
36	36.375	4.34	11.96	3.78	36.0	-
34	34.375	5.34	9.96	3.78	32.1	0.9
32	32.375	4.34	9.96	3.78	32.0	-
30	30.375	4.34	8.96	3.78	30.0	-
28	28.375	4.34	7.96	3.78	28.0	-
26	26.375	5.34	5.96	3.78	24.1	0.9
24	24.375	4.34	5.96	3.78	24.0	-
20	20.375	4.21	11.96	--	20.0	-
18	18.375	3.21	11.96	--	18.0	-
16U	16.375	4.65	7.08	--	15.5	0.2
18/18 B	--	--	--	--	--	-
16/16 B	--	--	--	--	--	-
15/15 B	--	--	--	--	--	-
14/14 B	--	--	--	--	--	-
12/12 B	--	--	--	--	--	-
9/9 B	--	--	--	--	--	-
18/18 M	--	--	--	--	--	-

Overall Length and Width Dimensions are + 1/16 inch

Four Panel Smooth

Height: 7'0"

	Smallest	Largest
Height Range:	80.0	84.0
Bore Location (from top, on center):	34.8 - 45.2	38.8 - 49.2
Bifold:	--	79.0

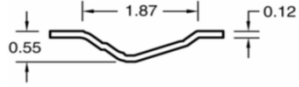

Patented INP Profile

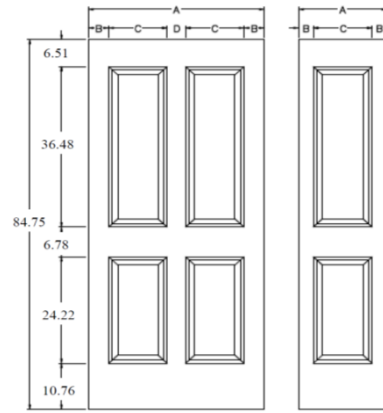

Door Facing Size (Nominal)	A	B	C	D	Smallest Allowable Door Width (if not next size down)	Max Trim, one side
36	36.375	4.34	11.96	3.78	36.0	-
34	34.375	5.34	9.96	3.78	32.1	0.9
32	32.375	4.34	9.96	3.78	32.0	-
30	30.375	4.34	8.96	3.78	30.0	-
28	28.375	4.34	7.96	3.78	28.0	-
26	26.375	5.34	5.96	3.78	24.1	0.9
24	24.375	4.34	5.96	3.78	24.0	-
20	20.375	4.21	11.96	--	20.0	-
18	18.375	3.21	11.96	--	18.0	-
16U	16.375	4.65	7.08	--	15.5	0.2
18/18 B	--	--	--	--	--	--
16/16 B	--	--	--	--	--	--
15/15 B	--	--	--	--	--	--
14/14 B	--	--	--	--	--	--
12/12 B	--	--	--	--	--	--
9/9 B	--	--	--	--	--	--
18/18 M	--	--	--	--	--	--

**Overall Length and Width Dimensions are + 1/16 inch

Four Panel Smooth

Height: 8'0"

	Smallest	Largest
Height Range:	88.0	96.0
Bore Location (from top, on center):	46.8 - 57.2	50.8 - 61.2
Bifold:	--	79.0

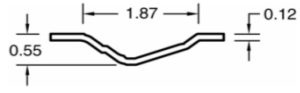

Patented INP Profile

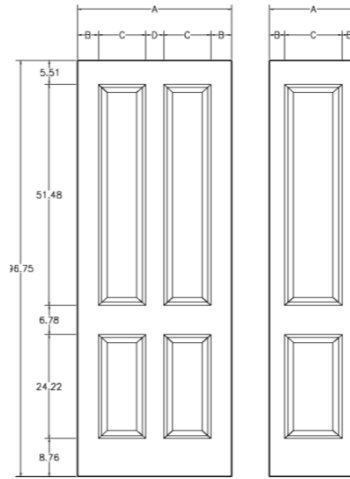

Door Facing Size (Nominal)	A	B	C	D	Smallest Allowable Door Width (if not next size down)	Max Trim, one side
36	36.375	4.34	11.96	3.78	36.0	-
34	34.375	5.34	9.96	3.78	32.1	0.9
32	32.375	4.34	9.96	3.78	32.0	-
30	30.375	4.34	8.96	3.78	30.0	-
28	28.375	4.34	7.96	3.78	28.0	-
26	26.375	5.34	5.96	3.78	24.1	0.9
24	24.375	4.34	5.96	3.78	24.0	-
20	20.375	4.21	11.96	--	20.0	-
18	18.375	3.21	11.96	--	18.0	-
16U	16.375	4.65	7.08	--	15.5	0.2
18/18 B	--	--	--	--	--	-
16/16 B	--	--	--	--	--	-
15/15 B	--	--	--	--	--	-
14/14 B	--	--	--	--	--	-
12/12 B	--	--	--	--	--	-
9/9 B	--	--	--	--	--	-
18/18 M	--	--	--	--	--	-

**Overall Length and Width Dimensions are + 1/16 inch

Four Panel Textured

Height: 6'8"

	<u>Smallest</u>	<u>Largest</u>
Height Range:	72.8	80.0
Bore Location (from top, on center):	39.2 - 42.8	42.3 - 45.9
Bifold:	--	79.0

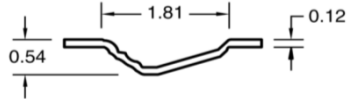

Cove & Bead Profile

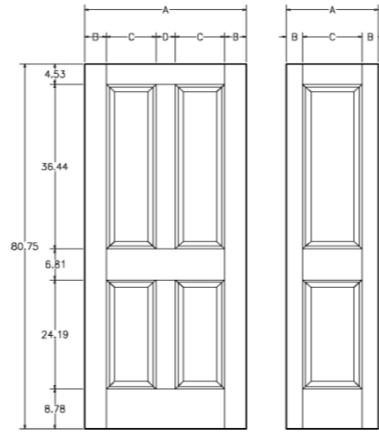

Door Facing Size (Nominal)	A	B	C	D	Smallest Allowable Door Width (if not next size down)	Max Trim, one side
36	36.375	4.34	11.94	3.81	36.0	-
34	34.375	5.34	9.94	3.81	32.1	0.9
32	32.375	4.34	9.94	3.81	32.0	-
30	30.375	4.34	8.94	3.81	30.0	-
28	28.375	4.34	7.94	3.81	28.0	-
26	26.375	5.34	5.94	3.81	26.0	-
24	24.375	4.34	5.94	3.81	24.0	-
20	20.375	4.22	11.94	--	20.0	-
18	18.375	3.22	11.94	--	18.0	-
16U	16.375	4.69	7.00	--	15.4	0.3
18/18 B	--	--	--	--	--	-
16/16 B	--	--	--	--	--	-
15/15 B	--	--	--	--	--	-
14/14 B	--	--	--	--	--	-
12/12 B	--	--	--	--	--	-
9/9 B	--	--	--	--	--	-
18/18 M	--	--	--	--	--	-

**Overall Length and Width Dimensions are + 1/16 inch

Four Panel Arch Top Textured

Height: 6'8"

	Smallest	Largest
Height Range:	72.3	80.0
Bore Location (from top, on center):	38.6 - 42.2	42.3 - 45.9
Bifold:	--	79.0

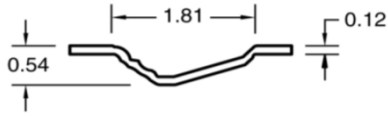

Cove and Bead Profile

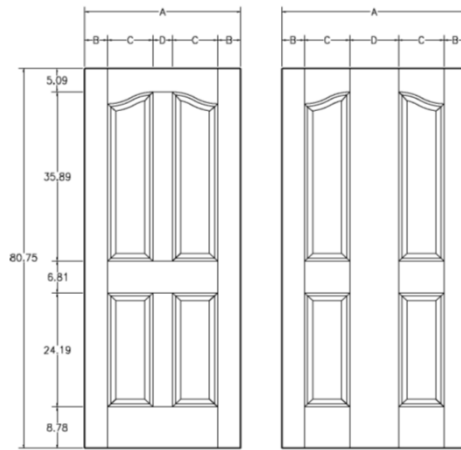

Door Facing Size (Nominal)	A	B	C	D	Smallest Allowable Door Width (if not next size down)	Max Trim, one side
36	36.375	4.34	11.94	3.81	36.0	-
34	34.375	5.34	9.94	3.81	32.1	0.9
32	32.375	4.34	9.94	3.81	32.0	-
30	30.375	4.34	8.94	3.81	30.0	-
28	28.375	4.34	7.94	3.81	28.0	-
26	26.375	5.34	5.94	3.81	26.0	-
24	24.375	4.34	5.94	3.81	24.0	-
20	--	--	--	--	--	-
18	--	--	--	--	--	-
16U	--	--	--	--	--	-
18/18 B	--	--	--	--	--	-
16/16 B	--	--	--	--	--	-
15/15 B	--	--	--	--	--	-
14/14 B	--	--	--	--	--	-
12/12 B	--	--	--	--	--	-
9/9 B	--	--	--	--	--	-
18/18 M	36.375	4.43	8.98	9.56	18/18	-

**Overall Length and Width Dimensions are + 1/16 inch

Six Panel Smooth

Height: 6'8"

	Smallest	Largest
Height Range:	72.9	80.0
Bore Location (from top, on center):	39.2 - 42.9	42.3 - 45.9
Bifold:	--	79.0

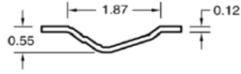

Patented INP Profile

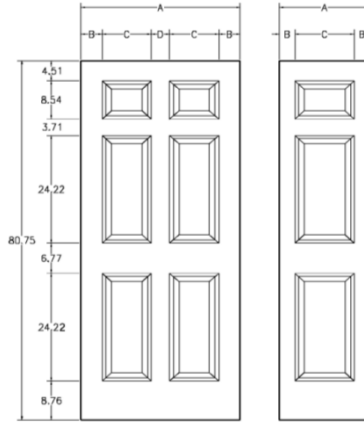

Door Facing Size (Nominal)	A	B	C	D	Smallest Allowable Door Width (if not next size down)	Max Trim, one side
36	36.375	4.34	11.96	3.78	36.0	-
34	34.375	5.34	9.96	3.78	32.1	0.9
32	32.375	4.34	9.96	3.78	32.0	-
30	30.375	4.34	8.96	3.78	30.0	-
28	28.375	4.34	7.96	3.78	28.0	-
26	26.375	5.34	5.96	3.78	24.1	0.9
24	24.375	4.34	5.96	3.78	24.0	-
20	20.375	4.21	11.96	--	20.0	-
18	18.375	3.21	11.96	--	18.0	-
16U	16.375	4.65	7.08	--	15.5	0.2
18/18 B	--	--	--	--	--	-
16/16 B	--	--	--	--	--	-
15/15 B	--	--	--	--	--	-
14/14 B	--	--	--	--	--	-
12/12 B	--	--	--	--	--	-
9/9 B	--	--	--	--	--	-
18/18 M	--	--	--	--	--	-

**Overall Length and Width Dimensions are + 1/16 inch

Six Panel Smooth

Height: 7'0"

	Smallest	Largest
Height Range:	80.0	84.0
Bore Location (from top, on center):	34.8 - 45.2	38.8 - 49.2
Bifold:	--	79.0

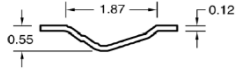

Patented INP Profile

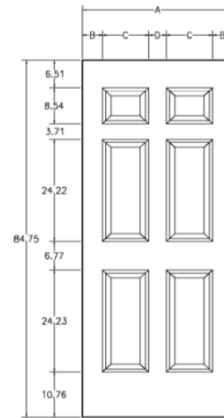

Door Facing Size (Nominal)	A	B	C	D	Smallest Allowable Door Width (if <u>not</u> next size down)	Max Trim, one side
36	36.375	4.34	11.96	3.78	36.0	-
34	34.375	5.34	9.96	3.78	32.1	0.9
32	32.375	4.34	9.96	3.78	32.0	-
30	30.375	4.34	8.96	3.78	30.0	-
28	28.375	4.34	7.96	3.78	28.0	-
26	26.375	5.34	5.96	3.78	24.1	0.9
24	24.375	4.34	5.96	3.78	24.0	-
20	--	--	--	--	--	-
18	18.375	3.21	11.96	--	18.0	-
16U	--	--	--	--	--	-
18/18 B	--	--	--	--	--	-
16/16 B	--	--	--	--	--	-
15/15 B	--	--	--	--	--	-
14/14 B	--	--	--	--	--	-
12/12 B	--	--	--	--	--	-
9/9 B	--	--	--	--	--	-
18/18 M	--	--	--	--	--	-

**Overall Length and Width Dimensions are + 1/16 inch

Six Panel Smooth

Height: 8'0"

	Smallest	Largest
Height Range:	88.0	96.0
Bore Location (from top, on center):	46.8 - 57.2	50.8 - 61.2
Bifold:	--	79.0

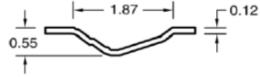

Patented INP Profile

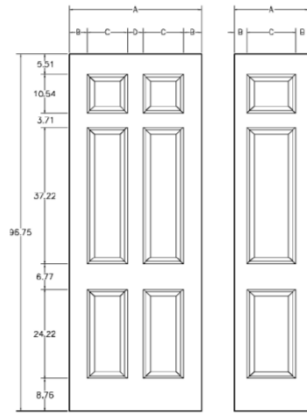

Door Facing Size (Nominal)	A	B	C	D	Smallest Allowable Door Width (if not next size down)	Max Trim, one side
36	36.375	4.34	11.96	3.78	36.0	-
34	34.375	5.34	9.96	3.78	32.1	0.9
32	32.375	4.34	9.96	3.78	32.0	-
30	30.375	4.34	8.96	3.78	30.0	-
28	28.375	4.34	7.96	3.78	28.0	-
26	26.375	5.34	5.96	3.78	24.1	0.9
24	24.375	4.34	5.96	3.78	24.0	-
20	20.375	4.21	11.96	--	20.0	-
18	18.375	3.21	11.96	--	18.0	-
16U	16.375	4.65	7.08	--	15.5	0.2
18/18 B	--	--	--	--	--	-
16/16 B	--	--	--	--	--	-
15/15 B	--	--	--	--	--	-
14/14 B	--	--	--	--	--	-
12/12 B	--	--	--	--	--	-
9/9 B	--	--	--	--	--	-
18/18 M	--	--	--	--	--	-

**Overall Length and Width Dimensions are + 1/16 inch

Six Panel Textured

	<u>Smallest</u>		<u>Largest</u>
Height Range:	72.8		80.0
Bore Location (from top, on center):	39.2 - 42.8		42.3 - 45.9
Bifold:	--		79.0

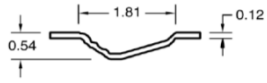

Cove and Bead Profile

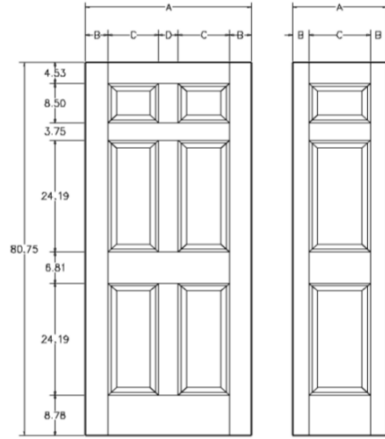

Height: 6'8"

Door Facing Size (Nominal)	A	B	C	D	Smallest Allowable Door Width (if not next size down)	Max Trim, one side
36	36.375	4.34	11.94	3.81	36.0	-
34	34.375	5.34	9.94	3.81	32.1	0.9
32	32.375	4.34	9.94	3.81	32.0	-
30	30.375	4.34	8.94	3.81	30.0	-
28	28.375	4.34	7.94	3.81	28.0	-
26	26.375	5.34	5.94	3.81	24.1	0.9
24	24.375	4.34	5.94	3.81	24.0	-
20	20.375	4.22	11.94	--	20.0	-
18	18.375	3.22	11.94	--	18.0	-
16U	16.375	4.69	7.00	--	15.4	0.3
18/18 B	--	--	--	--	--	-
16/16 B	--	--	--	--	--	-
15/15 B	--	--	--	--	--	-
14/14 B	--	--	--	--	--	-
12/12 B	--	--	--	--	--	-
9/9 B	18.375	3.22	4.81	2.31	8 / 8	-
18/18 M	--	--	--	--	--	-

**Overall Length and Width Dimensions are + 1/16 inch

Six Panel Textured

Height: 7'0"

	Smallest	Largest
Height Range:	80.0	84.0
Bore Location (from top, on center):	34.8 - 45.2	38.8 - 49.2
Bifold:	--	79.0

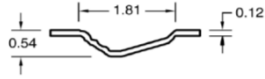

Cove and Bead Profile

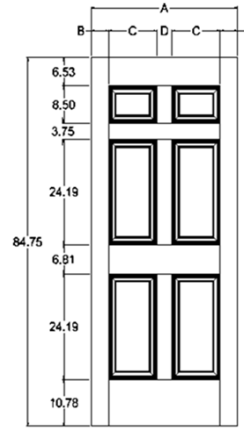

Door Facing Size (Nominal)	A	B	C	D	Smallest Allowable Door Width (if not next size down)	Max Trim, one side
36	36.375	4.34	11.94	3.81	36.0	-
34	34.375	5.34	9.94	3.81	32.1	0.9
32	32.375	4.34	9.94	3.81	32.0	-
30	30.375	4.34	8.94	3.81	30.0	-
28	28.375	4.34	7.94	3.81	28.0	-
26	--	--	--	--	--	-
24	24.375	4.34	5.94	3.81	24.0	-
20	--	--	--	--	--	-
18	--	--	--	--	--	-
16U	--	--	--	--	--	-
18/18 B	--	--	--	--	--	-
16/16 B	--	--	--	--	--	-
15/15 B	--	--	--	--	--	-
14/14 B	--	--	--	--	--	-
12/12 B	--	--	--	--	--	-
9/9 B	--	--	--	--	--	-
18/18 M	--	--	--	--	--	-

**Overall Length and Width Dimensions are + 1/16 inch

Six Panel Textured

Height: 8'0"

	<u>Smallest</u>	<u>Largest</u>
Height Range:	88.0	96.0
Bore Location (from top, on center):	46.8 - 57.2	50.8 - 61.2
Bifold:	--	79.0

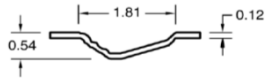

Cove and Bead Profile

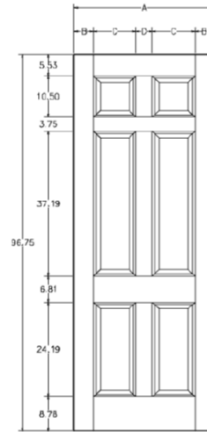

Door Facing Size (Nominal)	A	B	C	D	Smallest Allowable Door Width (if not next size down)	Max Trim, one side
36	36.375	4.34	11.94	3.81	36.0	-
34	34.375	5.34	9.94	3.81	32.1	0.9
32	32.375	4.34	9.94	3.81	32.0	-
30	30.375	4.34	8.94	3.81	30.0	-
28	28.375	4.34	7.94	3.81	28.0	-
26	--	--	--	--	--	-
24	24.375	4.34	5.94	3.81	24.0	-
20	--	--	--	--	--	-
18	--	--	--	--	--	-
16U	--	--	--	--	--	-
18/18 B	--	--	--	--	--	-
16/16 B	--	--	--	--	--	-
15/15 B	--	--	--	--	--	-
14/14 B	--	--	--	--	--	-
12/12 B	--	--	--	--	--	-
9/9 B	--	--	--	--	--	-
18/18 M	--	--	--	--	--	-

**Overall Length and Width Dimensions are + 1/16 inch

Six Panel Prestained Textured

Height: 6'8"

Amber Oak Honey Oak

Regal Oak Sienna Oak

	Smallest	Largest
Height Range:	72.9	80.0
Bore Location (from top, on center):	39.2 - 42.8	42.3 - 45.9
Bifold:	--	79.0

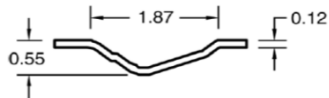

Patented INP Profile

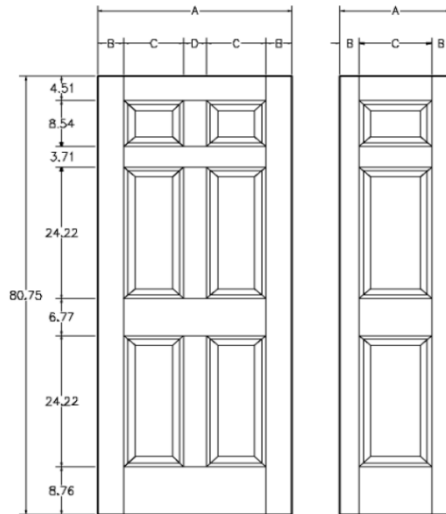

Door Facing Size (Nominal)	A	B	C	D	Smallest Allowable Door Width (if not next size down)	Max Trim, one side
36	36.375	4.34	11.96	3.78	36.0	-
34	34.375	5.34	9.96	3.78	32.1	0.9
32	32.375	4.34	9.96	3.78	32.0	-
30	30.375	4.34	8.96	3.78	30.0	-
28	28.375	4.34	7.96	3.78	28.0	-
26	26.375	5.34	5.96	3.78	24.1	0.9
24	24.375	4.34	5.96	3.78	24.0	-
20	20.375	4.21	11.96	--	20.0	-
18	18.375	3.21	11.96	--	18.0	-
16U	16.375	4.69	7.00	--	15.4	0.3
18/18 B	--	--	--	--	--	-
16/16 B	--	--	--	--	--	-
15/15 B	--	--	--	--	--	-
14/14 B	--	--	--	--	--	-
12/12 B	--	--	--	--	--	-
9/9 B	--	--	--	--	--	-
18/18 M	--	--	--	--	--	-

**Overall Length and Width Dimensions are + 1/16 inch

Six Panel White Textured

Height: 6'8"

	Smallest	Largest
Height Range:	72.8	80.0
Bore Location (from top, on center):	39.2 - 42.8	42.3 - 45.9
Bifold:	--	79.0

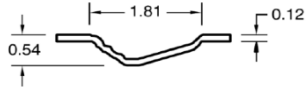

Cove and Bead Profile

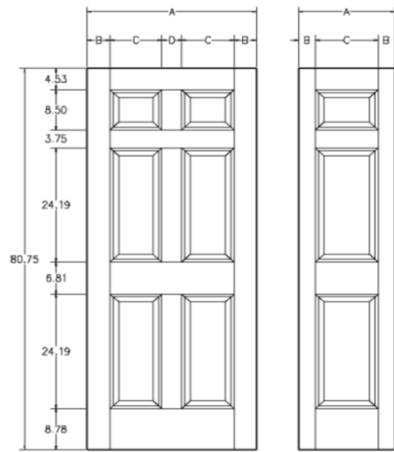

Door Facing Size (Nominal)	A	B	C	D	Smallest Allowable Door Width (if not next size down)	Max Trim, one side
36	36.375	4.34	11.94	3.81	36.0	-
34	34.375	5.34	9.94	3.81	32.1	0.9
32	32.375	4.34	9.94	3.81	32.0	-
30	30.375	4.34	8.94	3.81	30.0	-
28	28.375	4.34	7.94	3.81	28.0	-
26	26.375	5.34	5.94	3.81	24.1	0.9
24	24.375	4.34	5.94	3.81	24.0	-
20	20.375	4.22	11.94	--	20.0	-
18	18.375	3.22	11.94	--	18.0	-
16U	16.375	4.69	7.00	--	15.4	0.3
18/18 B	--	--	--	--	--	-
16/16 B	--	--	--	--	--	-
15/15 B	--	--	--	--	--	-
14/14 B	--	--	--	--	--	-
12/12 B	--	--	--	--	--	-
9/9 B	--	--	--	--	--	-
18/18 M	--	--	--	--	--	-

**Overall Length and Width Dimensions are + 1/16 inch

Six Panel Commercial Smooth

Height: 6'8"

	Smallest	Largest
Height Range:	72.0	80.0
Bore Location (from top, on center):	30.8 - 41.2	34.8 - 45.2
Bifold:	--	79.0

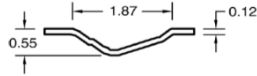

Patented INP Profile

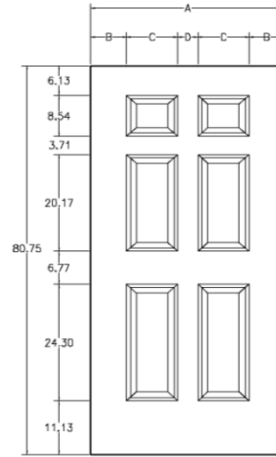

Door Facing Size (Nominal)	A	B	C	D	Smallest Allowable Door Width (if not next size down)	Max Trim, one side
42	42.375	6.69	12.61	3.78	next size down	1.0
36	36.375	6.69	9.61	3.78	next size down	1.0
34	--	--	--	--	--	--
32	32.375	6.69	7.61	3.78	next size down	1.0
30	30.375	5.69	7.61	3.78	next size down	1.0
28	--	--	--	--	--	--
26	--	--	--	--	--	--
24	--	--	--	--	--	--
20	--	--	--	--	--	--
18	--	--	--	--	--	--
16U	--	--	--	--	--	--
18/18 B	--	--	--	--	--	--
16/16 B	--	--	--	--	--	--
15/15 B	--	--	--	--	--	--
14/14 B	--	--	--	--	--	--
12/12 B	--	--	--	--	--	--
9/9 B	--	--	--	--	--	--
18/18 M	--	--	--	--	--	--

**Overall Length and Width Dimensions are + 1/16 inch

Six Panel Commercial Smooth

Height: 7'0"

	Smallest	Largest
Height Range:	80.0	84.0
Bore Location (from top, on center):	34.8 - 45.2	38.8 - 49.2
Bifold:	--	79.0

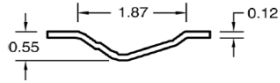

Patented INP Profile

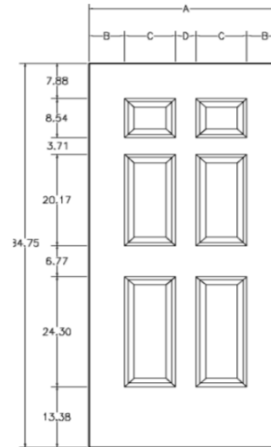

Door Facing Size (Nominal)	A	B	C	D	Smallest Allowable Door Width (if not next size down)	Max Trim, one side
42	42.375	6.69	12.61	3.78	next size down	1.0
36	36.375	6.69	9.61	3.78	next size down	1.0
34	--	--	--	--	--	-
32	32.375	6.69	7.61	3.78	next size down	1.0
30	30.375	5.69	7.61	3.78	next size down	1.0
28	--	--	--	--	--	-
26	--	--	--	--	--	-
24	--	--	--	--	--	-
20	--	--	--	--	--	-
18	--	--	--	--	--	-
16U	--	--	--	--	--	-
18/18 B	--	--	--	--	--	-
16/16 B	--	--	--	--	--	-
15/15 B	--	--	--	--	--	-
14/14 B	--	--	--	--	--	-
12/12 B	--	--	--	--	--	-
9/9 B	--	--	--	--	--	-
18/18 M	--	--	--	--	--	-

**Overall Length and Width Dimensions are + 1/16 inch

Riverside™

Height: 6'8"

	<u>Smallest</u>	<u>Largest</u>
Height Range:	72.9	80.0
Bore Location (from top, on center):	31.7 - 42.1	34.8 - 45.2
Bifold:	71.9	79.0

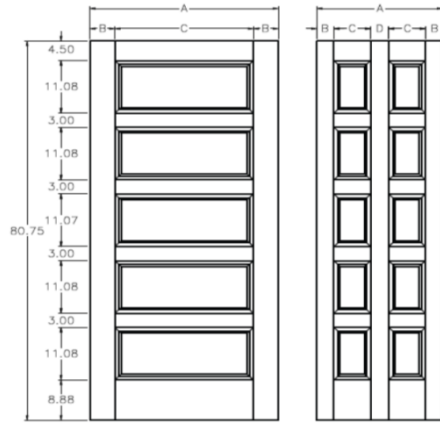
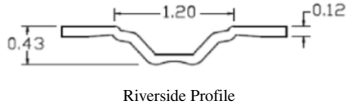

Door Facing Size (Nominal)	A	B	C	D	Smallest Allowable Door Width (if not next size down)	Max Trim, one side
36	36.375	4.9375	26.50	--	34.9	0.5
34	34.375	5.9375	22.50	--	next size down	1.0
32	32.375	4.9375	22.50	--	30.9	0.5
30	30.375	4.9375	20.50	--	28.9	0.5
28	28.375	4.9375	18.50	--	28.0	-
26	26.375	5.9375	14.50	--	26.0	-
24	24.375	4.9375	14.50	--	24.0	-
20	20.375	5.9375	8.50	--	20.0	-
18	18.375	4.9375	8.50	--	18.0	-
16U	16.375	5.3125	5.75	--	14.2	0.9
18/18 B	36.375	4.562	11.344	4.563	17 / 17	-
16/16 B	--	--	--	--	--	-
15/15 B	30.375	4.562	8.344	4.563	14 / 14	-
14/14 B	--	--	--	--	--	-
12/12 B	24.375	4.062	6.094	4.063	11 / 11	-
9/9 B	--	--	--	--	--	-
18/18 M	--	--	--	--	--	-

**Overall Length and Width Dimensions are + 1/16 inch

Riverside™

Height: 7'0"

	<u>Smallest</u>	<u>Largest</u>
Height Range:	80.0	84.0
Bore Location (from top, on center):	34.8 - 45.2	38.8 - 49.2
Bifold:	79.0	79.0

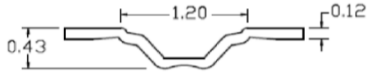

Riverside Profile

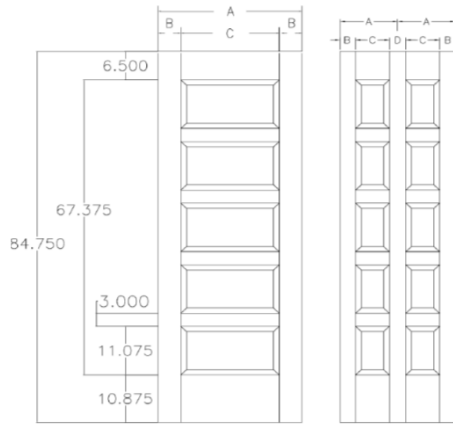

Door Facing Size (Nominal)	A	B	C	D	Smallest Allowable Door Width (if not next size down)	Max Trim, one side
36	36.375	4.9375	26.50	--	34.9	0.5
34	34.375	5.9375	22.50	--	next size down	1.0
32	32.375	4.9375	22.50	--	30.9	0.5
30	30.375	4.9375	20.50	--	28.9	0.5
28	28.375	4.9375	18.50	--	28.0	-
26	26.375	5.9375	14.50	--	26.0	-
24	24.375	4.9375	14.50	--	24.0	-
20	20.375	5.9375	8.50	--	20.0	-
18	18.375	4.9375	8.50	--	18.0	-
16U	16.375	5.3125	5.75	--	14.2	0.9
18/18 B	36.375	4.562	11.344	4.563	17 / 17	-
16/16 B	--	--	--	--	--	-
15/15 B	30.375	4.562	8.344	4.563	14 / 14	-
14/14 B	--	--	--	--	--	-
12/12 B	24.375	4.062	6.094	4.063	11 / 11	-
9/9 B	--	--	--	--	--	-
18/18 M	--	--	--	--	--	-

**Overall Length and Width Dimensions are + 1/16 inch

Riverside™

Height: 8'0"

	<u>Smallest</u>	<u>Largest</u>
Height Range:	88.9	96.0
Bore Location (from top, on center):	47.7 - 58.1	50.8 - 61.2
Bifold:	--	79.0

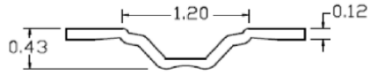

Riverside Profile

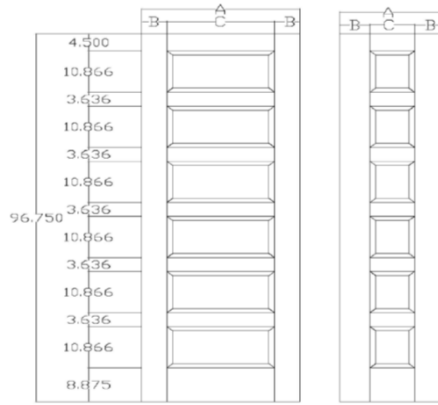

Door Facing Size (Nominal)	A	B	C		Smallest Allowable Door Width (if not next size down)	Max Trim, one side
36	36.375	4.9375	26.50		34.9	0.5
34	34.375	5.9375	22.50		next size down	1.0
32	32.375	4.9375	22.50		30.9	0.5
30	30.375	4.9375	20.50		28.9	0.5
28	28.375	4.9375	18.50		26.9	0.5
26	26.375	5.9375	14.50		next size down	1.0
24	24.375	4.9375	14.50		22.9	0.5
20	20.375	5.9375	8.50		next size down	1.0
18	18.375	4.9375	8.50		16.9	0.5
16U	16.375	5.3125	5.75		14.2	0.9
18/18 B	--	--	--		--	-
16/16 B	--	--	--		--	-
15/15 B	--	--	--		--	-
14/14 B	--	--	--		--	-
12/12 B	--	--	--		--	-
9/9 B	--	--	--		--	-
18/18 M	--	--	--		--	-

Saddlebrook™

Height: 6'8"

	Smallest	Largest
Height Range:	72.0	80.0
Bore Location (from top, on center):	30.8 - 41.2	34.8 - 45.2
Bifold:	--	79.0

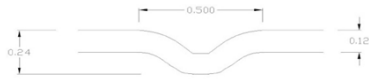

Saddlebrook Profile

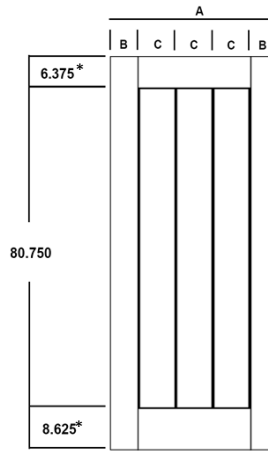

Door Facing Size (Nominal)	Number of Planks	A	B*	C*	Smallest Allowable Door Width (if not next size down)	Max Trim, one side
36	3	36.375	6.188	8.000	next size down	1.0
34	3	34.375	5.188	8.000	32.9	0.5
32	3	32.375	5.688	7.000	next size down	1.0
30	3	30.375	4.688	7.000	30.0	-
28	3	28.375	5.688	5.667	next size down	1.0
26	3	26.375	4.688	5.667	26.0	-
24	3	24.375	5.688	4.333	next size down	1.0
20	1	20.375	6.688	7.000	next size down	1.0
18	1	18.375	5.688	7.000	next size down	1.0
16	1	16.375	4.688	7.000	16.0	-
15	1	15.375	4.188	7.000	15.0	-
14	1	14.375	3.688	7.000	14.0	-
12	1	12.375	2.688	7.000	12.0	-
18/18 B		--	--	--	--	-
16/16 B		--	--	--	--	-
15/15 B		--	--	--	--	-
14/14 B		--	--	--	--	-
12/12 B		--	--	--	--	-
9/9 B		--	--	--	--	-

Overall Length and Width Dimensions are + 1/16 inch
 Panel measurements are to the center of the molded profile

Saddlebrook™

Height: 8'0"

	<u>Smallest</u>	<u>Largest</u>
Height Range:	88.0	96.0
Bore Location (from top, on center):	46.8 - 57.2	50.8 - 61.2
Bifold:	--	79.0

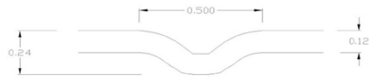

Saddlebrook Profile

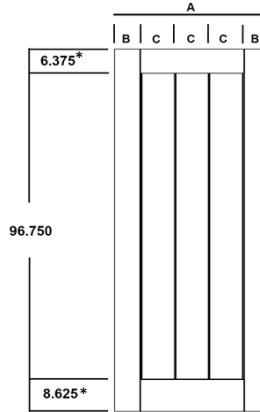

Door Facing Size (Nominal)	Number of Planks	A	B*	C*	Smallest Allowable Door Width (if not next size down)	Max Trim, one side
36	3	36.375	6.188	8.000	next size down	1.0
34	3	34.375	5.188	8.000	32.9	0.5
32	3	32.375	5.688	7.000	next size down	1.0
30	3	30.375	4.688	7.000	30.0	-
28	3	28.375	5.688	5.667	next size down	1.0
26	3	26.375	4.688	5.667	26.0	-
24	3	24.375	5.688	4.333	next size down	1.0
20	1	20.375	6.688	7.000	next size down	1.0
18	1	18.375	5.688	7.000	next size down	1.0
16	1	16.375	4.688	7.000	16.0	-
15	1	15.375	4.188	7.000	15.0	-
14	1	14.375	3.688	7.000	14.0	-
12	1	12.375	2.688	7.000	12.0	-
18/18 B		--	--	--	--	-
16/16 B		--	--	--	--	-
15/15 B		--	--	--	--	-
14/14 B		--	--	--	--	-
12/12 B		--	--	--	--	-
9/9 B		--	--	--	--	-

Overall Length and Width Dimensions are + 1/16 inch
 *Panel measurements are to the center of the molded profile

Cheyenne®

Height: 6'8"

	<u>Smallest</u>	<u>Largest</u>
Height Range:	72.9	80.0
Bore Location (from top, on center):	39.2 - 42.8	42.3 - 45.9
Bifold:	71.9	79.0

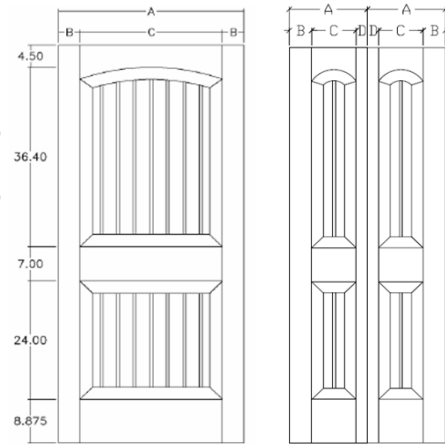
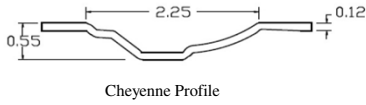

Door Facing Size (Nominal)	A	B	C	D	Smallest Allowable Door Width (if not next size down)	Max Trim, one side
36	36.375	4.3125	27.75	--	36.0	-
34	34.375	5.3125	23.75	--	32.2	0.9
32	32.375	4.3125	23.75	--	32.0	-
30	30.375	4.3125	21.75	--	30.0	-
28	28.375	4.3125	19.75	--	28.0	-
26	26.375	5.3125	15.75	--	24.2	0.9
24	24.375	4.3125	15.75	--	24.0	-
20	20.375	4.3500	11.675	--	20.0	-
18	18.375	3.3500	11.675	--	18.0	-
16U	16.375	4.4375	7.500	--	16.0	-
18/18 B	18.1875	4.375	11.625	2.1875	17 / 17	-
16/16 B	--	--	--	--	--	-
15/15 B	15.1875	4.375	8.625	2.1875	14 / 14	-
14/14 B	--	--	--	--	--	-
12/12 B	12.1875	3.4375	7.0313	1.7188	11 / 11	-
9/9 B	--	--	--	--	--	-
18/18 M	--	--	--	--	--	-

Overall Length and Width Dimensions are + 1/16 inch

Cheyenne®

Height: 8'0"

	<u>Smallest</u>	<u>Largest</u>
Height Range:	88.9	96.0
Bore Location (from top, on center):	47.7 - 58.1	50.8 - 61.2
Bifold:	--	79.0

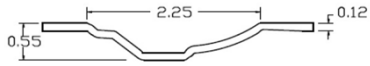

Cheyenne Profile

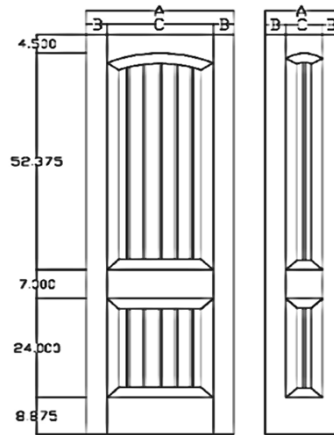

Door Facing Size (Nominal)	A	B	C	D	Smallest Allowable Door Width (if not next size down)	Max Trim, one side
36	36.375	4.3125	27.75	--	36.0	-
34	34.375	5.3125	23.75	--	32.2	0.9
32	32.375	4.3125	23.75	--	32.0	-
30	30.375	4.3125	21.75	--	30.0	-
28	28.375	4.3125	19.75	--	28.0	-
26	26.375	5.3125	15.75	--	24.2	0.9
24	24.375	4.3125	15.75	--	24.0	-
20	20.375	4.3500	11.675	--	20.0	-
18	18.375	3.3500	11.675	--	18.0	-
16U	16.375	4.4375	7.500	--	16.0	-
18/18 B	--	--	--	--	--	-
16/16 B	--	--	--	--	--	-
15/15 B	--	--	--	--	--	-
14/14 B	--	--	--	--	--	-
12/12 B	--	--	--	--	--	-
9/9 B	--	--	--	--	--	-
18/18 M	--	--	--	--	--	-

Overall Length and Width Dimensions are + 1/16 inch

Glenview™

Height: 6'8"

	<u>Smallest</u>	<u>Largest</u>
Height Range:	72.9	80.0
Bore Location (from top, on center):	31.7 - 42.1	34.8 - 45.2
Bifold:	71.9	79.0

Note: dimension E equals C+C+D

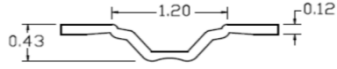

Glenview Profile

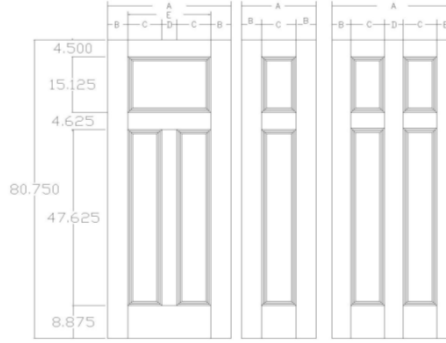

Door Facing Size (Nominal)	A	B	C	D	Smallest Allowable Door Width (if not next size down)	Max Trim, one side
36	36.375	4.9375	11.375	3.750	34.9	0.5
34	34.375	5.9375	9.375	3.750	next size down	1.0
32	32.375	4.9375	9.375	3.750	30.9	0.5
30	30.375	4.9375	8.375	3.750	28.9	0.5
28	28.375	4.9375	7.735	3.750	26.9	0.5
26	26.375	5.9375	5.375	3.750	next size down	1.0
24	24.375	4.9375	5.375	3.750	22.9	0.5
20	20.375	5.9375	8.500	--	next size down	1.0
18	18.375	4.9375	8.500	--	16.9	0.5
16U	16.375	5.9375	5.750	--	next size down	1.0
18/18 B	36.375	4.562	11.344	4.563	17 / 17	-
16/16 B	--	--	--	--	--	-
15/15 B	30.375	4.562	8.344	4.563	14 / 14	-
14/14 B	--	--	--	--	--	-
12/12 B	24.375	4.562	6.094	4.063	11 / 11	-
9/9 B	--	--	--	--	--	-
18/18 M	--	--	--	--	--	-

Overall Length and Width Dimensions are + 1/16 inch

Palazzo Series® Capri®

Height: 6'8"

	<u>Smallest</u>	<u>Largest</u>
Height Range:	72.0	80.0
Bore Location (from top, on center):	30.8 - 41.2	34.8 - 45.2
Bifold:	--	79.0

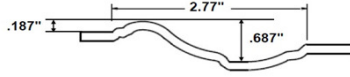

Palazzo™ Profile

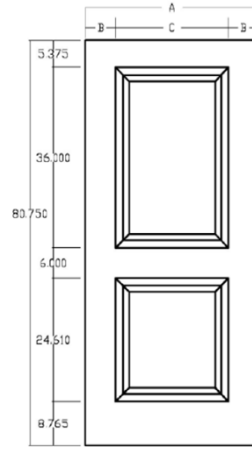

Door Facing Size (Nominal)	A	B	C	D	Smallest Allowable Door Width (if not next size down)	Max Trim, one side
36	36.375	6.34	23.69	--	next size down	1.0
34	34.375	6.34	21.69	--	next size down	1.0
32	32.375	5.34	21.69	--	30.1	0.9
30	30.375	5.34	19.69	--	28.1	0.9
28	28.375	5.34	17.69	--	26.1	0.9
26	26.375	5.34	15.69	--	24.1	0.9
24	24.375	4.34	15.69	--	24.0	-
20	20.375	4.21	11.96	--	20.0	-
18	18.375	3.21	11.96	--	18.0	-
16U	16.375	4.65	7.08	--	15.5	0.2
18/18 B	--	--	--	--	--	-
16/16 B	--	--	--	--	--	-
15/15 B	--	--	--	--	--	-
14/14 B	--	--	--	--	--	-
12/12 B	--	--	--	--	--	-
9/9 B	--	--	--	--	--	-
18/18 M	--	--	--	--	--	-

Overall Length and Width Dimensions are + 1/16 inch

Palazzo Series® Capri®

Height: 7'0"

	<u>Smallest</u>	<u>Largest</u>
Height Range:	80.0	84.0
Bore Location (from top, on center):	34.8 - 45.2	38.8 - 49.2
Bifold:	--	79.0



Palazzo™ Profile

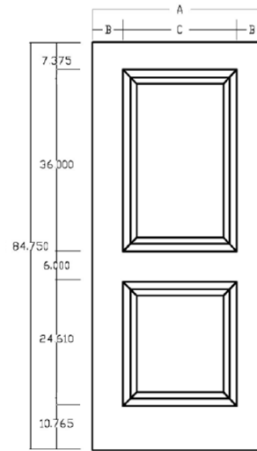

Door Facing Size (Nominal)	A	B	C	D	Smallest Allowable Door Width (if not next size down)	Max Trim, one side
36	36.375	6.34	23.69	--	next size down	1.0
34	34.375	6.34	21.69	--	next size down	1.0
32	32.375	5.34	21.69	--	30.1	0.9
30	30.375	5.34	19.69	--	28.1	0.9
28	28.375	5.34	17.69	--	26.1	0.9
26	26.375	5.34	15.69	--	24.1	0.9
24	24.375	4.34	15.69	--	24.0	-
20	20.375	4.21	11.96	--	20.0	-
18	18.375	3.21	11.96	--	18.0	-
16U	16.375	4.65	7.08	--	15.5	0.2
18/18 B	--	--	--	--	--	-
16/16 B	--	--	--	--	--	-
15/15 B	--	--	--	--	--	-
14/14 B	--	--	--	--	--	-
12/12 B	--	--	--	--	--	-
9/9 B	--	--	--	--	--	-
18/18 M	--	--	--	--	--	-

Overall Length and Width Dimensions are + 1/16 inch

Palazzo Series® Capri®

Height: 8'0"

	<u>Smallest</u>	<u>Largest</u>
Height Range:	88.0	96.0
Bore Location (from top, on center):	46.8 - 57.2	50.8 - 61.2
Bifold:	--	79.0



Palazzo™ Profile

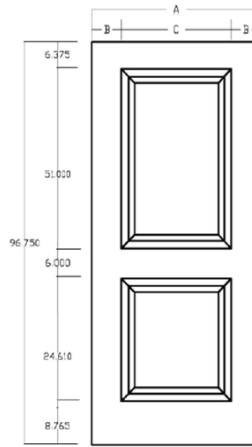

Door Facing Size (Nominal)	A	B	C	D	Smallest Allowable Door Width (if not next size down)	Max Trim, one side
36	36.375	6.34	23.69	--	next size down	1.0
34	34.375	6.34	21.69	--	next size down	1.0
32	32.375	5.34	21.69	--	30.1	0.9
30	30.375	5.34	19.69	--	28.1	0.9
28	28.375	5.34	17.69	--	26.1	0.9
26	26.375	5.34	15.69	--	24.1	0.9
24	24.375	4.34	15.69	--	24.0	-
20	20.375	4.21	11.96	--	20.0	-
18	18.375	3.21	11.96	--	18.0	-
16U	16.375	4.65	7.08	--	15.5	0.2
18/18 B	--	--	--	--	--	-
16/16 B	--	--	--	--	--	-
15/15 B	--	--	--	--	--	-
14/14 B	--	--	--	--	--	-
12/12 B	--	--	--	--	--	-
9/9 B	--	--	--	--	--	-
18/18 M	--	--	--	--	--	-

Overall Length and Width Dimensions are + 1/16 inch

Palazzo Series® Bellagio®

Height: 6'8"

	<u>Smallest</u>	<u>Largest</u>
Height Range:	72.0	80.0
Bore Location (from top, on center):	30.8 - 41.2	34.8 - 45.2
Bifold:	--	79.0

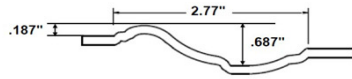

Palazzo™ Profile

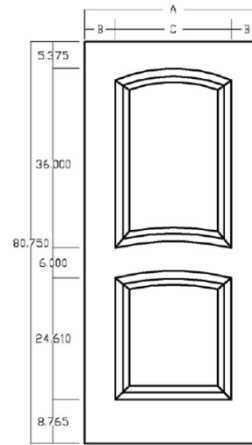

Door Facing Size (Nominal)	A	B	C	D	Smallest Allowable Door Width (if not next size down)	Max Trim, one side
36	36.375	6.34	23.69	--	next size down	1.0
34	34.375	6.34	21.69	--	next size down	1.0
32	32.375	5.34	21.69	--	30.1	0.9
30	30.375	5.34	19.69	--	28.1	0.9
28	28.375	5.34	17.69	--	26.1	0.9
26	26.375	5.34	15.69	--	24.1	0.9
24	24.375	4.34	15.69	--	24.0	-
20	20.375	4.21	11.96	--	20.0	-
18	18.375	3.21	11.96	--	18.0	-
16U	16.375	4.65	7.08	--	15.5	0.2
18/18 B	--	--	--	--	--	-
16/16 B	--	--	--	--	--	-
15/15 B	--	--	--	--	--	-
14/14 B	--	--	--	--	--	-
12/12 B	--	--	--	--	--	-
9/9 B	--	--	--	--	--	-
18/18 M	--	--	--	--	--	-

Overall Length and Width Dimensions are + 1/16 inch

Palazzo Series® Bellagio®

Height: 7'0"

	<u>Smallest</u>	<u>Largest</u>
Height Range:	80.0	84.0
Bore Location (from top, on center):	34.8 - 45.2	38.8 - 49.2
Bifold:	--	79.0

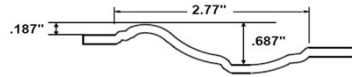

Palazzo™ Profile

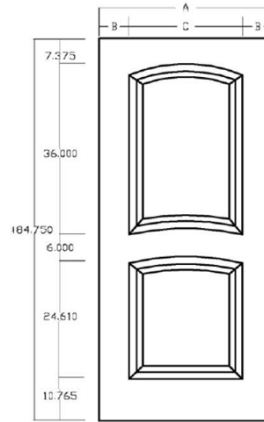

Door Facing Size (Nominal)	A	B	C	D	Smallest Allowable Door Width (if not next size down)	Max Trim, one side
36	36.375	6.34	23.69	--	next size down	1.0
34	34.375	6.34	21.69	--	next size down	1.0
32	32.375	5.34	21.69	--	30.1	0.9
30	30.375	5.34	19.69	--	28.1	0.9
28	28.375	5.34	17.69	--	26.1	0.9
26	26.375	5.34	15.69	--	24.1	0.9
24	24.375	4.34	15.69	--	24.0	-
20	20.375	4.21	11.96	--	20.0	-
18	18.375	3.21	11.96	--	18.0	-
16U	16.375	4.65	7.08	--	15.5	0.2
18/18 B	--	--	--	--	--	--
16/16 B	--	--	--	--	--	--
15/15 B	--	--	--	--	--	--
14/14 B	--	--	--	--	--	--
12/12 B	--	--	--	--	--	--
9/9 B	--	--	--	--	--	--
18/18 M	--	--	--	--	--	--

Overall Length and Width Dimensions are + 1/16 inch

Palazzo Series® Bellagio®

Height: 8'0"

	<u>Smallest</u>	<u>Largest</u>
Height Range:	88.0	96.0
Bore Location (from top, on center):	46.8 - 57.2	50.8 - 61.2
Bifold:	--	79.0

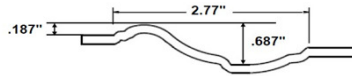

Palazzo™ Profile

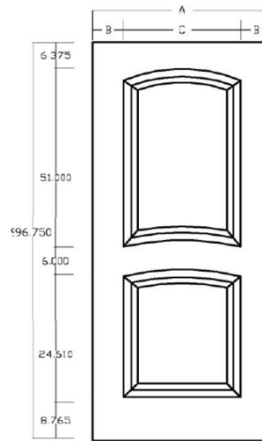

Door Facing Size (Nominal)	A	B	C	D	Smallest Allowable Door Width (if not next size down)	Max Trim, one side
36	36.375	6.34	23.69	--	next size down	1.0
34	34.375	6.34	21.69	--	next size down	1.0
32	32.375	5.34	21.69	--	30.1	0.9
30	30.375	5.34	19.69	--	28.1	0.9
28	28.375	5.34	17.69	--	26.1	0.9
26	26.375	5.34	15.69	--	24.1	0.9
24	24.375	4.34	15.69	--	24.0	-
20	20.375	4.21	11.96	--	20.0	-
18	18.375	3.21	11.96	--	18.0	-
16U	16.375	4.65	7.08	--	15.5	0.2
18/18 B	--	--	--	--	--	-
16/16 B	--	--	--	--	--	-
15/15 B	--	--	--	--	--	-
14/14 B	--	--	--	--	--	-
12/12 B	--	--	--	--	--	-
9/9 B	--	--	--	--	--	-
18/18 M	--	--	--	--	--	-

Overall Length and Width Dimensions are + 1/16 inch

Palazzo Series ® Treviso®

Height: 6'8"

	Smallest	Largest
Height Range:	72.0	80.0
Bore Location (from top, on center):	30.8 - 41.2	34.8 - 45.2
Bifold:	--	79.0

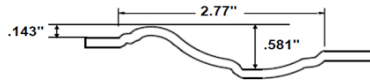

Palazzo™ Treviso™ Profile

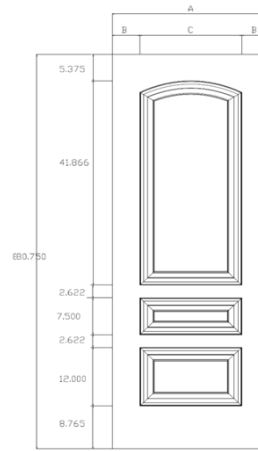

Door Facing Size (Nominal)	A	B	C	D	Smallest Allowable Door Width (if not next size down)	Max Trim, one side
36	36.375	6.34	23.69	--	next size down	1.0
34	34.375	6.34	21.69	--	next size down	1.0
32	32.375	5.34	21.69	--	30.1	0.9
30	30.375	5.34	19.69	--	28.1	0.9
28	28.375	5.34	17.69	--	26.1	0.9
26	26.375	5.50	15.37	--	next size down	1.0
24	24.375	4.50	15.37	--	23.8	0.1
20	20.375	5.50	9.37	--	next size down	1.0
18	18.375	4.50	9.37	--	17.8	0.1
16U	16.375	4.65	7.07	--	15.5	0.2
18/18 B	--	--	--	--	--	-
16/16 B	--	--	--	--	--	-
15/15 B	--	--	--	--	--	-
14/14 B	--	--	--	--	--	-
12/12 B	--	--	--	--	--	-
9/9 B	--	--	--	--	--	-
18/18 M	--	--	--	--	--	-

Overall Length and Width Dimensions are + 1/16 inch

Palazzo Series ® Treviso®

Height: 7'0"

	Smallest	Largest
Height Range:	80.0	84.0
Bore Location (from top, on center):	34.8 - 45.2	38.8 - 49.2
Bifold:	--	79.0

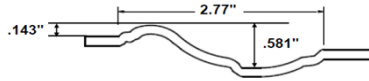

Palazzo™ Treviso™ Profile

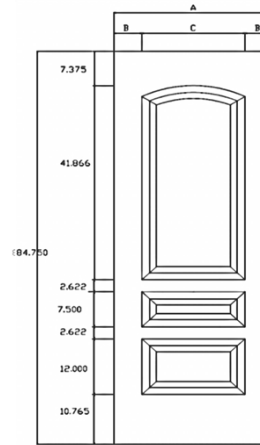

Door Facing Size (Nominal)	A	B	C	D	Smallest Allowable Door Width (if not next size down)	Max Trim, one side
36	36.375	6.34	23.69	--	next size down	1.0
34	34.375	6.34	21.69	--	next size down	1.0
32	32.375	5.34	21.69	--	30.1	0.9
30	30.375	5.34	19.69	--	28.1	0.9
28	28.375	5.34	17.69	--	26.1	0.9
26	26.375	5.50	15.37	--	next size down	1.0
24	24.375	4.50	15.37	--	23.8	0.1
20	20.375	5.50	9.37	--	next size down	1.0
18	18.375	4.50	9.37	--	17.8	0.1
16U	16.375	4.65	7.07	--	15.5	0.2
18/18 B	--	--	--	--	--	-
16/16 B	--	--	--	--	--	-
15/15 B	--	--	--	--	--	-
14/14 B	--	--	--	--	--	-
12/12 B	--	--	--	--	--	-
9/9 B	--	--	--	--	--	-
18/18 M	--	--	--	--	--	-

Overall Length and Width Dimensions are + 1/16 inch

Palazzo Series ® Treviso®

Height: 8'0"

	Smallest	Largest
Height Range:	88.0	96.0
Bore Location (from top, on center):	46.8 - 57.2	50.8 - 61.2
Bifold:	--	79.0

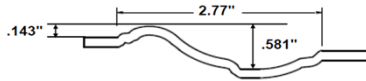

Palazzo™ Treviso™ Profile

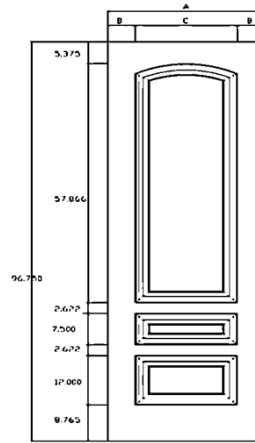

Door Facing Size (Nominal)	A	B	C	D	Smallest Allowable Door Width (if <u>not</u> next size down)	Max Trim, one side
36	36.375	6.34	23.69	--	next size down	1.0
34	34.375	6.34	21.69	--	next size down	1.0
32	32.375	5.34	21.69	--	30.1	0.9
30	30.375	5.34	19.69	--	28.1	0.9
28	28.375	5.34	17.69	--	26.1	0.9
26	26.375	5.50	15.37	--	next size down	1.0
24	24.375	4.50	15.37	--	23.8	0.1
20	20.375	5.50	9.37	--	next size down	1.0
18	18.375	4.50	9.37	--	17.8	0.1
16U	16.375	4.65	7.07	--	15.5	0.2
18/18 B	--	--	--	--	--	-
16/16 B	--	--	--	--	--	-
15/15 B	--	--	--	--	--	-
14/14 B	--	--	--	--	--	-
12/12 B	--	--	--	--	--	-
9/9 B	--	--	--	--	--	-
18/18 M	--	--	--	--	--	-

Overall Length and Width Dimensions are + 1/16 inch

West End™ Collection

Melrose™

Height: 6'8"

	Smallest	Largest
Height Range:	72.0	80.0
Bore Location (from top, on center):	30.8 - 41.2	34.8 - 45.2
Bifold:	--	79.0

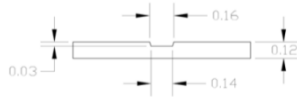
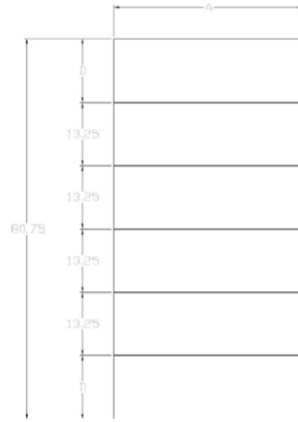

Embossed Groove Profile

Door Facing Size (Nominal)	A	D	--	Smallest Allowable Door Width (if <u>not</u> next size down)	Max Trim, one side
36	36.375	13.48	--	next size down	1.0
34	34.375	13.48	--	next size down	1.0
32	32.375	13.48	--	next size down	1.0
30	30.375	13.48	--	next size down	1.0
28	28.375	13.48	--	next size down	1.0
26	26.375	13.48	--	next size down	1.0
24	24.375	13.48	--	next size down	1.0
22	22.375	13.48	--	next size down	1.0
20	20.375	13.48	--	next size down	1.0
18	18.375	13.48	--	next size down	1.0
16	16.375	13.48	--	next size down	1.0
15	14.375	13.48	--	next size down	1.0
14	12.375	13.48	--	next size down	1.0
12	10.375	13.48	--	next size down	-
18/18 B	--	--	--	--	-
16/16 B	--	--	--	--	-
15/15 B	--	--	--	--	-
14/14 B	--	--	--	--	-
12/12 B	--	--	--	--	-

**Overall Length and Width Dimensions are + 1/16 inch

West End™ Collection

Melrose™

Height: 7'0"

	Smallest	Largest
Height Range:	80.0	84.0
Bore Location (from top, on center):	34.8 - 45.2	38.8 - 49.2
Bifold:	--	79.0

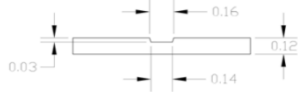

Embossed Groove Profile

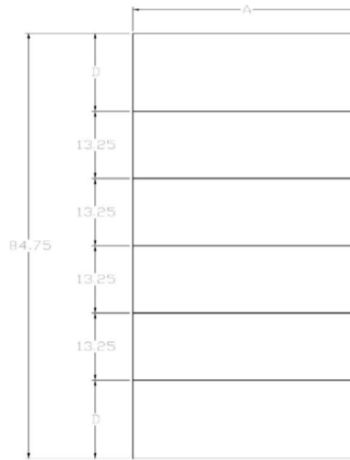

Door Facing Size (Nominal)	A	D	--	Smallest Allowable Door Width (if <u>not</u> next size down)	Max Trim, one side
36	36.375	15.48	--	next size down	1.0
34	34.375	15.48	--	next size down	1.0
32	32.375	15.48	--	next size down	1.0
30	30.375	15.48	--	next size down	1.0
28	28.375	15.48	--	next size down	1.0
26	26.375	15.48	--	next size down	1.0
24	24.375	15.48	--	next size down	1.0
22	22.375	15.48	--	next size down	1.0
20	20.375	15.48	--	next size down	1.0
18	18.375	15.48	--	next size down	1.0
16	16.375	15.48	--	next size down	1.0
15	14.375	15.48	--	next size down	1.0
14	12.375	15.48	--	next size down	1.0
12	10.375	15.48	--	next size down	-
18/18 B	--	--	--	--	--
16/16 B	--	--	--	--	--
15/15 B	--	--	--	--	--
14/14 B	--	--	--	--	--
12/12 B	--	--	--	--	--

**Overall Length and Width Dimensions are + 1/16 inch

West End™ Collection

Berkley™

Height: 6'8"

	Smallest	Largest
Height Range:	72.0	80.0
Bore Location (from top, on center):	30.8 - 41.2	34.8 - 45.2
Bifold:	--	79.0

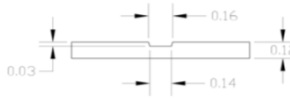

Embossed Groove Profile

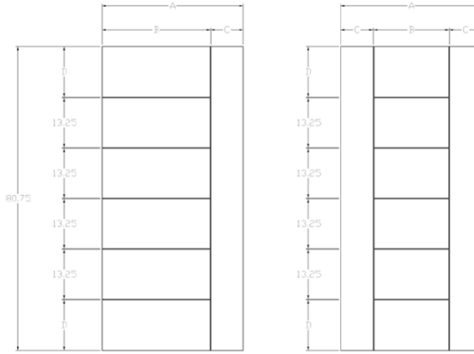

Door Facing Size (Nominal)	A	B	C	D	Smallest Allowable Door Width (if <u>not</u> next size down)	Max Trim, one side
36	36.375	28.00	8.38	13.48	next size down	1.0
34	34.375	26.00	8.38	13.48	next size down	1.0
32	32.375	24.00	8.38	13.48	next size down	1.0
30	30.375	22.00	8.38	13.48	next size down	1.0
28	28.375	18.98	9.40	13.48	next size down	1.0
26	26.375	18.00	8.38	13.48	next size down	1.0
24	24.375	16.00	8.38	13.48	next size down	1.0
22	22.375	16.00	6.38	13.48	next size down	1.0
20	20.375	14.00	6.38	13.48	next size down	1.0
18	18.375	12.00	6.38	13.48	next size down	1.0
16	16.375	12.00	4.38	13.48	16.0	1.0
15	15.375	11.00	4.38	13.48	15.0	1.0
14	14.375	10.00	4.38	13.48	14.0	1.0
12	12.375	8.00	4.38	13.48	12.0	-
18/18 B	see literature for bifold size availability					
16/16 B						
15/15 B						
14/14 B						
12/12 B						

*Overall Length and Width Dimensions are + 1/16 inch

West End™ Collection

Berkley™

Height: 7'0"

	Smallest	Largest
Height Range:	80.0	84.0
Bore Location (from top, on center):	34.8 - 45.2	38.8 - 49.2
Bifold:	--	79.0

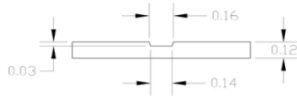

Embossed Groove Profile

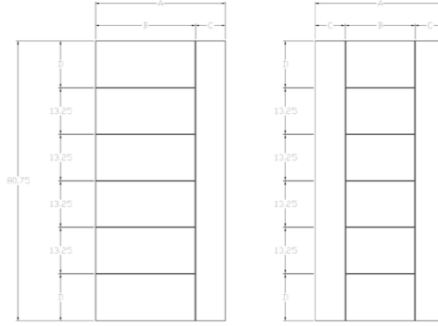

Door Facing Size (Nominal)	A	B	C	D	Smallest Allowable Door Width (if not next size down)	Max Trim, one side
36	36.375	28.00	8.38	15.48	36.0	1.0
34	34.375	26.00	8.38	15.48	34.0	1.0
32	32.375	24.00	8.38	15.48	32.0	1.0
30	30.375	22.00	8.38	15.48	30.0	1.0
28	28.375	18.98	9.40	15.48	28.0	1.0
26	26.375	18.00	8.38	15.48	26.0	1.0
24	24.375	16.00	8.38	15.48	24.0	1.0
22	22.375	16.00	6.38	15.48	22.0	1.0
20	20.375	14.00	6.38	15.48	20.0	1.0
18	18.375	12.00	6.38	15.48	18.0	1.0
16	16.375	12.00	4.38	15.48	16.0	1.0
15	15.375	11.00	4.38	15.48	15.0	1.0
14	14.375	10.00	4.38	15.48	14.0	1.0
12	12.375	8.00	4.38	15.48	12.0	-
18/18 B	see literature for bifold size availability					
16/16 B						
15/15 B						
14/14 B						
12/12 B						

**Overall Length and Width Dimensions are + 1/16 inch

West End™ Collection

Hamel™

Height: 6'8"

	Smallest	Largest
Height Range:	72.0	80.0
Bore Location (from top, on center):	30.8 - 41.2	34.8 - 45.2
Bifold:	--	79.0

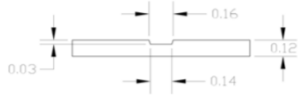

Embossed Groove Profile

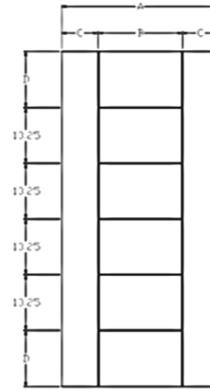

Door Facing Size (Nominal)	A	B	C	D	Smallest Allowable Door Width (if <u>not</u> next size down)	Max Trim, one side
36	36.375	19.25	8.56	13.48	next size down	1.0
34	34.375	19.25	7.56	13.48	next size down	1.0
32	32.375	19.25	6.56	13.48	next size down	1.0
30	30.375	19.25	5.56	13.48	next size down	1.0
28	28.375	19.25	4.56	13.48	next size down	1.0
26	26.375	15.47	5.45	13.48	next size down	1.0
24	24.375	15.47	4.45	13.48	24.0	-
22	N/A	N/A	N/A	N/A	N/A	N/A
20	N/A	N/A	N/A	N/A	N/A	N/A
18	N/A	N/A	N/A	N/A	N/A	N/A
16	N/A	N/A	N/A	N/A	N/A	N/A
15	N/A	N/A	N/A	N/A	N/A	N/A
14	N/A	N/A	N/A	N/A	N/A	N/A
12	N/A	N/A	N/A	N/A	N/A	N/A
18/18 B	see literature for bifold size availability					
16/16 B						
15/15 B						
14/14 B						
12/12 B						

*Overall Length and Width Dimensions are + 1/16 inch

West End™ Collection

Hamel™

Height: 7'0"

	Smallest	Largest
Height Range:	80.0	84.0
Bore Location (from top, on center):	34.8 - 45.2	38.8 - 49.2
Bifold:	--	79.0

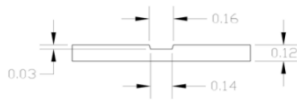

Embossed Groove Profile

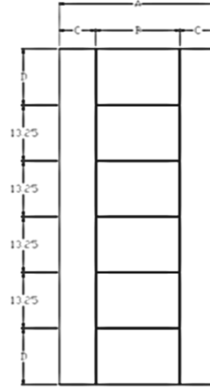

Door Facing Size (Nominal)	A	B	C	D	Smallest Allowable Door Width (if <u>not</u> next size down)	Max Trim, one side
36	36.375	19.25	8.56	15.48	next size down	1.0
34	34.375	19.25	7.56	15.48	next size down	1.0
32	32.375	19.25	6.56	15.48	next size down	1.0
30	30.375	19.25	5.56	15.48	next size down	1.0
28	28.375	19.25	4.56	15.48	next size down	1.0
26	26.375	15.47	5.45	15.48	next size down	1.0
24	24.375	15.47	4.45	15.48	24.0	-
22	N/A	N/A	N/A	N/A	N/A	N/A
20	N/A	N/A	N/A	N/A	N/A	N/A
18	N/A	N/A	N/A	N/A	N/A	N/A
16	N/A	N/A	N/A	N/A	N/A	N/A
15	N/A	N/A	N/A	N/A	N/A	N/A
14	N/A	N/A	N/A	N/A	N/A	N/A
12	N/A	N/A	N/A	N/A	N/A	N/A
18/18 B	see literature for bifold size availability					
16/16 B						
15/15 B						
14/14 B						
12/12 B						

**Overall Length and Width Dimensions are + 1/16 inch

Winslow

Height: 6'8"

	<u>Smallest</u>		<u>Largest</u>
Height Range:	72.5		80.0
Bore Location (from top, on center):	31.3 - 41.7		34.8 - 45.2
Bifold:	--		79.0

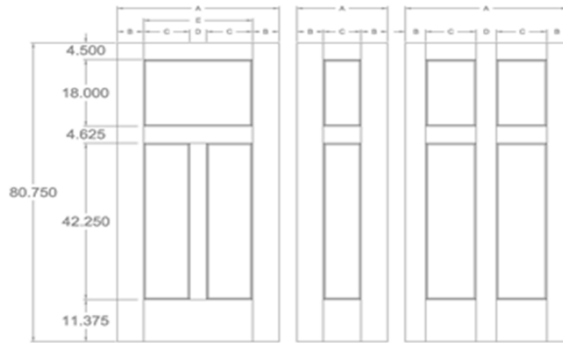

Door Facing Size (Nominal)	A	B	C	D	E	Smallest Allowable Door Width (if not next size down)	Max Trim, one side
36	36.375	5.94	10.38	3.75	24.50	next size down	1.0
34	34.375	4.94	10.38	3.75	24.50	32.9	0.5
32	32.375	5.94	8.38	3.75	20.50	next size down	1.0
30	30.375	4.94	8.38	3.75	20.50	28.9	0.5
28	28.375	5.94	6.38	3.75	16.50	next size down	1.0
26	26.375	4.94	6.38	3.75	16.50	24.9	0.5
24	24.375	4.94	5.38	3.75	14.50	22.9	0.5
20	20.375	5.94	8.50	--	--	N/A	N/A
18	18.375	4.94	8.50	--	--	N/A	N/A
16U	16.375	5.31	5.75	--	--	N/A	N/A
18/18 B	36.375	4.56	11.34	4.56	--	N/A	N/A
16/16 B	--	--	--	--	--	N/A	N/A
15/15 B	30.375	4.56	8.34	4.56	--	N/A	N/A
14/14 B	--	--	--	--	--	N/A	N/A
12/12 B	24.375	4.06	6.09	4.06	--	N/A	N/A
9/9 B	--	--	--	--	--	N/A	N/A
18/18 M	--	--	--	--	--	N/A	N/A

**Overall Length and Width Dimensions are + 1/16 inch

Winslow

Height: 7'0"

	<u>Smallest</u>	<u>Largest</u>
Height Range:	80.0	84.0
Bore Location (from top, on center):	34.8 - 45.2	38.8 - 49.2
Bifold:	--	79.0

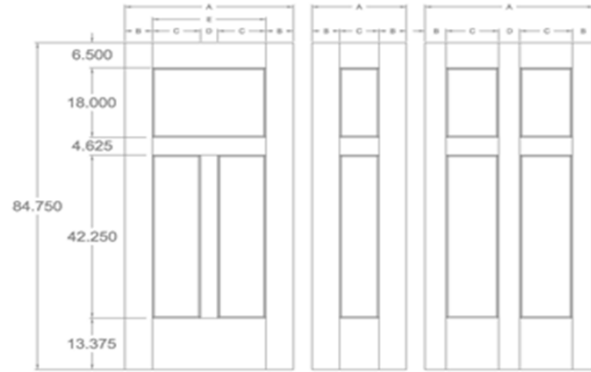
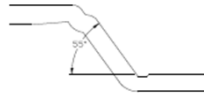

Door Facing Size (Nominal)	A	B	C	D	E	Smallest Allowable Door Width (if not next size down)	Max Trim, one side
36	36.375	5.94	10.38	3.75	24.50	next size down	1.0
34	34.375	4.94	10.38	3.75	24.50	32.9	0.5
32	32.375	5.94	8.38	3.75	20.50	next size down	1.0
30	30.375	4.94	8.38	3.75	20.50	28.9	0.5
28	28.375	5.94	6.38	3.75	16.50	next size down	1.0
26	26.375	4.94	6.38	3.75	16.50	24.9	0.5
24	24.375	4.94	5.38	3.75	14.50	22.9	0.5
20	20.375	5.94	8.50	--	--	next size down	1.0
18	18.375	4.94	8.50	--	--	16.9	0.5
16U	16.375	5.31	5.75	--	--	N/A	N/A
18/18 B	36.375	4.56	11.34	4.56	--	N/A	N/A
16/16 B	--	--	--	--	--	N/A	N/A
15/15 B	30.375	4.56	8.34	4.56	--	N/A	N/A
14/14 B	--	--	--	--	--	N/A	N/A
12/12 B	24.375	4.06	6.09	4.06	--	N/A	N/A
9/9 B	--	--	--	--	--	N/A	N/A
18/18 M	--	--	--	--	--	N/A	N/A

**Overall Length and Width Dimensions are + 1/16 inch

Lincoln Park

Height: 6'8"

	<u>Smallest</u>		<u>Largest</u>
Height Range:	72.5		80.0
Bore Location (from top, on center):	34.8 - 45.2		34.8 - 45.2
Bifold:	--		79.0

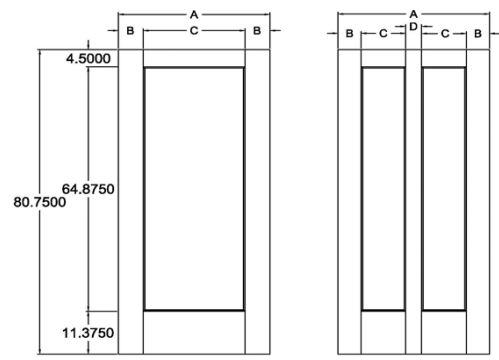

Door Facing Size (Nominal)	A	B	C	D	Smallest Allowable Door Width (if not next size down)	Max Trim, one side
36	36.375	5.94	24.50		next size down	1.0
34	34.375	5.94	22.50		next size down	1.0
32	32.375	4.94	22.50		30.9	0.5
30	30.375	4.94	20.50		28.9	0.5
28	28.375	4.94	18.50		26.9	0.5
26	26.375	5.94	14.50		next size down	1.0
24	24.375	4.94	14.50		22.9	0.5
20	20.375	5.94	8.50	--	next size down	1.0
18	18.375	4.94	8.50	--	16.9	0.5
16U	16.375	5.31	5.75	--	N/A	N/A
18/18 B	36.375	5.56	10.72	3.81	N/A	N/A
16/16 B	--	--	--	--	N/A	N/A
15/15 B	30.375	4.56	8.72	3.81	N/A	N/A
14/14 B	--	--	--	--	N/A	N/A
12/12 B	24.375	4.44	5.84	3.81	N/A	N/A
9/9 B	--	--	--	--	N/A	N/A
18/18 M	--	--	--	--	N/A	N/A

Overall Length and Width Dimensions are + 1/16 inch

Lincoln Park

Height: 7'0"

	Smallest	Largest
Height Range:	80.0	84.0
Bore Location (from top, on center):	35.3 - 45.7	38.8 - 49.2
Bifold:	--	83.0

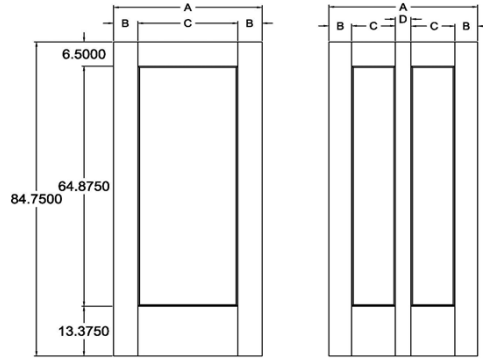
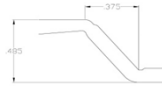

Door Facing Size (Nominal)	A	B	C	D	Smallest Allowable Door Width (if not next size down)	Max Trim, one side
36	36.375	5.94	24.50		next size down	1.0
34	34.375	5.94	22.50		next size down	1.0
32	32.375	4.94	22.50		30.9	0.5
30	30.375	4.94	20.50		28.9	0.5
28	28.375	4.94	18.50		26.9	0.5
26	26.375	5.94	14.50		next size down	1.0
24	24.375	4.94	14.50		22.9	0.5
20	20.375	5.94	8.50	--	next size down	1.0
18	18.375	4.94	8.50	--	16.9	0.5
16U	16.375	5.31	5.75	--	N/A	N/A
18/18 B	36.375	5.56	10.72	3.81	N/A	N/A
16/16 B	--	--	--	--	N/A	N/A
15/15 B	30.375	4.56	8.72	3.81	N/A	N/A
14/14 B	--	--	--	--	N/A	N/A
12/12 B	24.375	4.44	5.84	3.81	N/A	N/A
9/9 B	--	--	--	--	N/A	N/A
18/18 M	--	--	--	--	N/A	N/A

Overall Length and Width Dimensions are + 1/16 inch

Lincoln Park

Height: 8'0"

	<u>Smallest</u>		<u>Largest</u>
Height Range:	88.5	88.5	96.0
Bore Location (from top, on center):	47.3 - 57.7	47.3 - 57.7	50.8 - 61.2
Bifold:	--	--	95.0

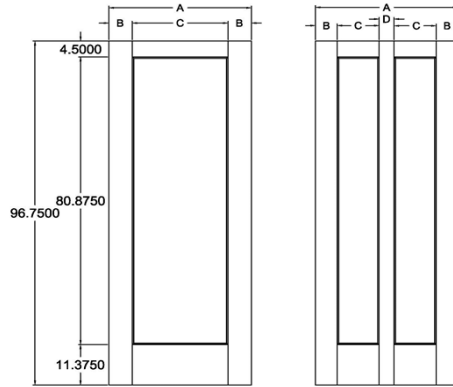

Door Facing Size (Nominal)	A	B	C	D	Smallest Allowable Door Width (if not next size down)	Max Trim, one side
36	36.375	5.94	24.50		next size down	1.0
34	34.375	5.94	22.50		next size down	1.0
32	32.375	4.94	22.50		30.9	0.5
30	30.375	4.94	20.50		28.9	0.5
28	28.375	4.94	18.50		26.9	0.5
26	26.375	5.94	14.50		next size down	1.0
24	24.375	4.94	14.50		22.9	0.5
20	20.375	5.94	8.50	--	next size down	1.0
18	18.375	4.94	8.50	--	16.9	0.5
16U	16.375	5.31	5.75	--	N/A	N/A
18/18 B	36.375	5.56	10.72	3.81	N/A	N/A
16/16 B	--	--	--	--	N/A	N/A
15/15 B	30.375	4.56	8.72	3.81	N/A	N/A
14/14 B	--	--	--	--	N/A	N/A
12/12 B	24.375	4.44	5.84	3.81	N/A	N/A
9/9 B	--	--	--	--	N/A	N/A
18/18 M	--	--	--	--	N/A	N/A

Overall Length and Width Dimensions are + 1/16 inch

Logan

Height: 6'8"

	<u>Smallest</u>	<u>Largest</u>
Height Range:	72.5	80.0
Bore Location (from top, on center):	34.8 - 45.2	34.8 - 45.2
Bifold:	--	79.0

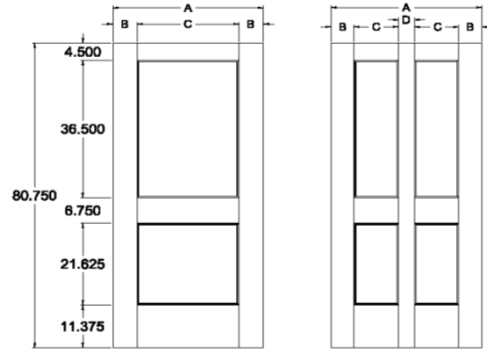

Door Facing Size (Nominal)	A	B	C	D	Smallest Allowable Door Width (if not next size down)	Max Trim, one side
36	36.375	5.94	24.50		next size down	1.0
34	34.375	5.94	22.50		next size down	1.0
32	32.375	4.94	22.50		30.9	0.5
30	30.375	4.94	20.50		28.9	0.5
28	28.375	4.94	18.50		26.9	0.5
26	26.375	5.94	14.50		next size down	1.0
24	24.375	4.94	14.50		22.9	0.5
20	20.375	5.94	8.50	--	next size down	1.0
18	18.375	4.94	8.50	--	16.9	0.5
16U	16.375	4.94	6.50	--	N/A	N/A
18/18 B	36.375	5.56	10.72	3.81	N/A	N/A
16/16 B	--	--	--	--	N/A	N/A
15/15 B	30.375	4.56	8.72	3.81	N/A	N/A
14/14 B	--	--	--	--	N/A	N/A
12/12 B	24.375	4.19	6.09	3.81	N/A	N/A
9/9 B	--	--	--	--	N/A	N/A
18/18 M	--	--	--	--	N/A	N/A

Overall Length and Width Dimensions are + 1/16 inch

Logan

Height: 7'0"

	<u>Smallest</u>	<u>Largest</u>
Height Range:	80.0	84.0
Bore Location (from top, on center):	35.3 - 45.7	38.8 - 49.2
Bifold:	--	83.0

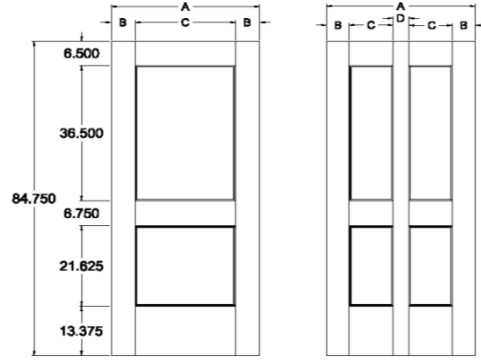

Door Facing Size (Nominal)	A	B	C	D	Smallest Allowable Door Width (if not next size down)	Max Trim, one side
36	36.375	5.94	24.50		next size down	1.0
34	34.375	5.94	22.50		next size down	1.0
32	32.375	4.94	22.50		30.9	0.5
30	30.375	4.94	20.50		28.9	0.5
28	28.375	4.94	18.50		26.9	0.5
26	26.375	5.94	14.50		next size down	1.0
24	24.375	4.94	14.50		22.9	0.5
20	20.375	5.94	8.50	--	next size down	1.0
18	18.375	4.94	8.50	--	16.9	0.5
16U	16.375	4.94	6.50	--	N/A	N/A
18/18 B	36.375	5.56	10.72	3.81	N/A	N/A
16/16 B	--	--	--	--	N/A	N/A
15/15 B	30.375	4.56	8.72	3.81	N/A	N/A
14/14 B	--	--	--	--	N/A	N/A
12/12 B	24.375	4.19	6.09	3.81	N/A	N/A
9/9 B	--	--	--	--	N/A	N/A
18/18 M	--	--	--	--	N/A	N/A

Overall Length and Width Dimensions are + 1/16 inch

Logan

Height: 8'0"

	<u>Smallest</u>		<u>Largest</u>
Height Range:	88.5	88.5	96.0
Bore Location (from top, on center):	47.3 - 57.7	47.3 - 57.7	50.8 - 61.2
Bifold:	--	--	95.0

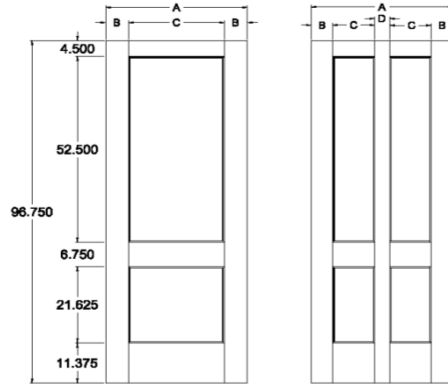

Door Facing Size (Nominal)	A	B	C	D	Smallest Allowable Door Width (if not next size down)	Max Trim, one side
36	36.375	5.94	24.50		next size down	1.0
34	34.375	5.94	22.50		next size down	1.0
32	32.375	4.94	22.50		30.9	0.5
30	30.375	4.94	20.50		28.9	0.5
28	28.375	4.94	18.50		26.9	0.5
26	26.375	5.94	14.50		next size down	1.0
24	24.375	4.94	14.50		22.9	0.5
20	20.375	5.94	8.50	--	next size down	1.0
18	18.375	4.94	8.50	--	16.9	0.5
16U	16.375	4.94	6.50	--	N/A	N/A
18/18 B	36.375	5.56	10.72	3.81	N/A	N/A
16/16 B	--	--	--	--	N/A	N/A
15/15 B	30.375	4.56	8.72	3.81	N/A	N/A
14/14 B	--	--	--	--	N/A	N/A
12/12 B	24.375	4.19	6.09	3.81	N/A	N/A
9/9 B	--	--	--	--	N/A	N/A
18/18 M	--	--	--	--	N/A	N/A

Overall Length and Width Dimensions are + 1/16 inch